



MAGELLAN™

32 Zone Wireless Transceiver Security Systems

MG5000 V4.5

MG5050 V4.5

SP
SPECTRA®

4 to 32 Zone Expandable Security Systems

SP4000 V4.5

SP5500 V4.5

SP6000 V4.5

SP7000 V4.5

STAY D™

Always Armed,
Never Disarmed

Programming Guide

P **▲** **R** **▲** **D** **O** **X**®
S E C U R I T Y S Y S T E M S

PARADOX.COM

Warranty

For complete warranty information on this product please refer to the Limited Warranty Statement found on the website www.paradox.com/terms. Your use of the Paradox product signifies your acceptance of all warranty terms and conditions.

Limitations of Alarm Systems:

It must be understood that while your Paradox alarm system is highly advanced and secure, it does not offer any guaranteed protection against burglary, fire or other emergency (fire and emergency options are only available on certain Paradox models). This is due to a number of reasons, including but not limited to inadequate or improper installation/positioning, sensor limitations, battery performance, wireless signal interruption, inadequate maintenance or the potential for the system or telephone lines to be compromised or circumvented. As a result, Paradox does not represent that the alarm system will prevent personal injury or property damage, or in all cases provide adequate warning or protection.

Your security system should therefore be considered as one of many tools available to reduce risk and/or damage of burglary, fire or other emergencies, such other tools include but are not limited to insurance coverage, fire prevention and extinguish devices, and sprinkler systems.

We also strongly recommend that you regularly maintain your security systems and stay aware of new and improved Paradox products and developments.

TBR-21: In order to comply with TBR-21, standard force dialing must be enabled.

UL AND ULC WARNINGS

This equipment has the capability of being programmed with features not verified for use in UL installations. To stay within UL and ULC standards, the installer should use the following guidelines when configuring the system:

- All components of the system should be UL listed for the intended application.
- If used for "Fire" detection, the installer should refer to NFPA Standards #72, Chapter 2. In addition, once installation is complete, the local fire authority must be notified of the installation.
- WARNING: This equipment must be installed and maintained by qualified service personnel only
- This equipment must be verified by a qualified technician once every three years.
- All keypads must use an anti-tamper switch.
- Do not bypass fire zones.
- Maximum allowed entry delay is 45 seconds.
- Maximum allowed exit delay is 60 seconds.
- Minimum 4 minutes for bell cut-off time.
- The following features do not comply with UL requirements: Bypass Recall and Auto Trouble Shutdown.
- Do not connect the primary indicating device to a relay. The installer must use the bell output.
- To comply with UL985, the auxiliary power output should not exceed 200mA.
- Do not connect the zone ground terminal with UL Listed products.
- The metallic enclosure must be grounded to the cold water pipe.
- All outputs are Class 2 or power-limited, except for the battery terminal. The Class 2 and power-limited fire alarm circuits shall be installed using CL3, CL3R, CL3P, or substitute cable permitted by the National Electrical Code, ANSI/NFPA 70.
- EOL resistor part #2011002000
- **For UL Installations:** Universal UB1640W 16.5VAC min **40VA**
- All outputs are rated from 11.3Vdc to 12.7Vdc
- 12Vdc 4Ah rechargeable acid/lead or gel cell backup battery (YUASA model #NP7-12 recommended) for residential use. Use a 7Ah battery to comply with fire requirements.
- Wheelock 46T-12 siren

Legal

© 2010 Paradox Security Systems Ltd. All rights reserved. Specifications may change without prior notice. One or more of the following US patents may apply: 7046142, 6215399, 6111256, 6104319, 5920259, 5886632, 5721542, 5287111, 5119069, 5077549 and RE39406. Canadian and international patents may also apply. Magellan, Spectra SP, WinLoad and BabyWare are trademarks or registered trademarks of Paradox Security Systems Ltd. or its affiliates in Canada, the United States and/or other countries.

Table of Contents

System Overview	3	Ademco Contact ID Report Codes	39
Comparison Chart	4	Automatic Report Code List	40
Specifications	5	Installer Function Keys	41
Entering Programming Mode	5	Trouble Display	42
Data Entry & Display	6	Wireless Repeater Programming (RPT1)	43
Important Settings and Modes	6	Wireless Keypad Programming (K32RF / K37)	45
System Codes	7	Wireless Siren Programming	46
System Planning	8	LCD Keypad Labels (K32LCD)	47
Zone Programming	12	User Programming	50
Keypad Programming	18	Hardware Connections	55
Partition Programming	19	Connecting to WinLoad / BabyWare	57
System Programming	20	Updating Firmware Using WinLoad / BabyWare	57
Daylight Savings Programming	21	Metal Box Installation	58
Communication Programming	22	Installer Quick Menu	65
Programmable Output Programming	29	Index	68
System Report Codes	36		

Conventions

Default Settings: Options which are bold signify the default value:
 e.g. Access code length: 6 digits **4 digits** (4 digits is the default value)

WARNING: Important information	NOTE: Suggestion or reminder	 Quick Menu (see page 65)
---------------------------------------	-------------------------------------	--

System Overview

Module	Description	Maximum number per system	Current Consumption
K32RF, K37	32-Zone Wireless Keypad Modules	8 total	Wireless
K10V/H K32 K32LCD K35 K636	10 and 32-Zone Hardwired Keypad Module	15 total including ZX8 and RTX3	K10V/H: Min. = 44mA / Max. = 72mA K32: Min. = 49mA / Max. = 148mA K32LCD: Min. = 43mA / Max. = 86mA K35: Min. = 30mA / Max. = 70mA K636: Min. = 28mA / Max. = 33mA
ZX8 ZX8SP	8-Zone Expansion Module	3	Min. = 29mA / Max. = 31mA
RPT1	Magellan Wireless Repeater Module	2	Average = 57mA
VDMP3	Plug-In Voice Dialer	1	Min. = 28mA / Max. = 28mA
IP100	Internet Module	1	Min. = 90mA / Max. = 120mA
RTX3	Wireless Expansion Module (Spectra SP only)	1	Min. = 61mA / Max. = 143mA
RX1	Wireless Receiver (Spectra SP only)	1	Min. = 26mA / Max. = 61mA
PCS200	Paradox Communicator Module	1	Min. = 80mA / Max. = 600mA

Important System Notes

Please refer to the following module compatibility exceptions to ensure proper system function:

- Wireless keypads can be used with MG/SP systems that include an RTX3 (not compatible with SP4000 systems).
- When using a K636 keypad, only partition 1 is available.
- The following modules are not compatible with SP4000 systems: K32RF, K37, K32LCD, RPT1.
- When using an SP Series panel, all wireless sections and options do not apply unless an RTX3 is used in conjunction with the panel.
- When using an SP6000 panel in conjunction with an RTX3, all K32 and K10V/H keypads must be versions 2.0 or higher.
- The K35 Fixed LCD keypad module is only compatible with MG/SP panels version 2.3 and higher.

Comparison Chart

Security Features	MG5000	MG5050
StayD	✓	✓
Built-in transceiver	✓	✓
Maximum zones	32*	32*
On-board zones	2 (4 with ATZ)	5 (10 with ATZ)
Expansion zones (ZX8)	24 (3 x ZX8)	24 (3 x ZX8)
Keypad zones	15	15
Partitions	2	2
User Codes	32	32
Remote controls	32	32
PGMs	16* (2 on-board)	16* (4 on-board)
PGM +/- trigger	-	✓
Alarm relay (panel relay)	-	-
Event buffer	256	256
Wireless keypads (K32RF and K37)	8	8
Wireless repeaters (RPT1)	2	2
Wireless sirens (SR150)	4	4
2-wire smoke detector input	✓	✓
GPRS/GSM communication (PCS Series)	✓	✓
Internet TCP/IP communication (IP100)	✓	✓
Plug-in voice module (VDMP3)	✓	✓
Personal dialing	✓	✓
Pager reporting	✓	✓
Upload/download software	WinLoad	WinLoad
In-field firmware upgradeable	✓	✓

Feature	SP4000	SP5500	SP6000	SP7000
StayD	✓	✓	✓	✓
Built-in transceiver	-	-	-	-
Maximum zones	32	32*	32*	32*
On-board zones	4 (8 with ATZ)	5 (10 with ATZ)	8 (16 with ATZ)	16 (32 with ATZ)
Expansion zones (ZX8)	24 (3 x ZX8)	24 (3 x ZX8)	24 (3 x ZX8)	24 (2 x ZX8)
Keypad zones	15	15	15	15
Partitions	2	2	2	2
User codes	32	32	32	32
PGMs	12 (1 on-board)	16* (2 on-board)	16* (2+2** on-board)	16* (4 on-board)
PGM +/- trigger	-	-	✓	✓
Alarm relay (panel relay)	-	-	1**	1
Event buffer	256	256	256	256
Remote control	32	32	32	32
Wireless keypads (K32RF and K37)	-	8	8	8
Wireless repeaters (RPT1)	-	2	2	2
Wireless sirens (SR150)	-	4	4	4
Wireless expansion (RTX3)	✓***	✓	✓	✓
Wireless expansion (RX1)	✓†	✓	✓	✓
2-wire smoke detector input	-	-	✓	✓
GPRS/GSM communication (PCS Series)	✓	✓	✓	✓
Internet TCP/IP communication (IP100)	✓	✓	✓	✓
Plug-in voice module (VDMP3)	✓	✓	✓	✓
Personal dialing	✓	✓	✓	✓
Pager reporting	✓	✓	✓	✓
Upload/download software	BabyWare‡	WinLoad	WinLoad	WinLoad
In-field firmware upgradeable	✓	✓	✓	✓

* Any of which can be wireless

** Optional

*** When used with an SP4000 system, the RTX3 only allows for the use of remote controls.

† When used with an SP4000 system, the RX1 only allows for the use of one-way remote controls.

‡ For compatible BabyWare version, refer to paradox.com.

Specifications

MG5000 / MG5050	
Power rating	16.5 VAC (50 or 60Hz) minimum 20 VA (40 VA recommended)
Aux. power	600 mA typical, 700 mA maximum, fuseless shutdown at 1.1A
Battery	12 VDC, 4Ah/7Ah
Battery charging current	350 mA
On-board zones	MG5000: 2 MG5050: 5
Bell output	1A (fuseless shutdown at 3A)
On-board PGMs	MG5000: 2 MG5050: 4 (1+/- trigger) All on-board PGMs are 100mA low-current outputs
Dimensions	MG5000: 14 x 10.4cm (5.5 x 4.1") MG5050: 19 x 10.2cm (7.5 x 4")
Operating temperature	0°C to 50°C (32°F to 122°F)

SP4000 / SP5500 / SP6000 / SP7000		
Power rating	16.5Vac (50 or 60Hz) minimum 20VA (40VA recommended)	
Aux. power	SP4000: 450mA, fuseless shutdown at 650mA	SP5500 / SP6000 / SP7000: 600mA typical, 700mA maximum, fuseless shutdown at 1.1A
Battery	12Vdc, 4Ah/7Ah	
Battery charging current	SP4000: Limited by 1.1A supply current (AUX consumption - no dedicated battery current limit circuit)	SP5500: 350 mA SP6000 / SP7000: 350 mA / 850 mA
On-board zones	SP4000: 4 SP5500: 5	SP6000: 8 SP7000: 16
Bell output	1A (fuseless shutdown at 3A)	
On-board PGMs	SP4000: 1 SP5500: 2 (all +/- trigger) All on-board PGMs are 100mA low-current outputs	SP6000: 2+(2 optional) (all +/- trigger) SP7000: 4 (all +/- trigger)
Dimensions	SP4000: 14 x 6.6cm (5.5 x 2.6") SP5500: 19 x 8.9cm (7.5 x 3.5")	SP6000: 19 x 8.9cm (7.5 x 3.5") SP7000: 20.3 x 10.8cm (8 x 4.25")
Operating temperature	0°C to 50°C (32°F to 122°F)	

Entering Programming Mode

WARNING: StayD Mode must be deactivated in order to enter programming mode. To deactivate StayD, press [OFF] + [MASTER / USER CODE] + [OFF].

1. Press [ENTER].
2. Enter your [INSTALLER CODE] (default: 000000) or [MAINTENANCE CODE] (no default). [ARM] and [STAY] lights flash. To modify codes, see *System Codes* on page 50.
3. Enter the 3-digit [SECTION] you wish to program ([ARM] and [STAY] lights are ON).
4. Enter required [DATA].

Data Entry & Display

To access the Data Display Mode, press the **[ENTER]** key after entering a section and before entering any data. The four LEDs/Icon as indicated below will begin to flash indicating that you are in the Data Display Mode.



K636

K10V/H

K35/K37

K32RF/K32

Each time the **[ENTER]** key is pressed, the keypad will display the next digit in the current section and will continue through all the following sections one digit at a time without changing the programmed values. Not available for sections using the Multiple Feature Select Method. Press the **[CLEAR]** key at any time to exit the Data Display Mode.

There are two methods that can be used to enter data when in programming mode: Single Digit Data Entry and Feature Select Programming methods:

Single Digit Data Entry Method

After entering programming mode, some sections will require that you enter decimal values from 000 to 255. Other sections will require that you enter hexadecimal values from 0 to F. The required data will be clearly indicated in this manual. When entering the final digit in a section, the panel will automatically save and advance to the next section. Refer to *Decimal and Hexadecimal Values* on page 6 to see the keys and their equivalent decimal and/or hexadecimal value.

Feature Select Programming Method

After entering certain sections, eight options will be displayed where each option from **[1]** to **[8]** represents a specific feature. Press the key corresponding to the desired option. This means the option is ON. Press the key again to remove the digit, thereby, turning OFF the option. Press the **[SLEEP]** key to set all eight options to OFF. When the options are set, press the **[ENTER]** key to save and advance to the next section.

Important Settings and Modes

Section Description

- [950]** Reset all programmable sections to factory default values
- [955]** Clear bus module trouble (remove disconnected module from the bus)
- [960]** Wireless transmitter serial number display (press any button on the assigned remote control or press the tamper switch of the wireless module, then press **[ENTER]** to view the next digit)
- [970]** Download memory key into panel (see the Reference & Installation Manual)
- [975]** Upload panel into the memory key (see the Reference & Installation Manual)
- [980]** Display version number of the panel (press **[ENTER]** to view the next digit)

Decimal and Hexadecimal Values

Value or Action	What Do I Press?	What Do I See?	
		32-zone LED	10-zone LED
Value 0 / Replace Current Digit with 0	[SLEEP]	Erase digit and remain in section	Erase digit and remain in section
Values 1 to 9	[1] TO [9]	Zone 1 to 9	Keys 1 to 9
A (hex only)	[0]	Zone 10	Key 0(10)
B (hex only)	[OFF]	Zone 11	OFF
C (hex only)	[BYP]	Zone 12	BYP
D (hex only)	[MEM]	Zone 13	MEM
E (hex only)	[TBL]	Zone 14	TBL
F (hex only)	[⏻]	Zone 15	[⏻]
Exit Without Saving	[CLEAR]	Arm & Stay LED flash	Arm & Stay LED flash
Save Data (hex only)	[ENTER]	Advances to the next section	Advances to the next section

System Codes

Installer Code (Default: 0000 / 000000)	The Installer code is used to enter programming mode, which allows you to program everything <u>except</u> user codes. To change the default code, go to section [397] on page 50 and refer to section [701] option [1] on page 50.
Maintenance Code (No Default)	The Maintenance code is used to enter programming mode, which allows you to program everything <u>except</u> for user codes and communication settings (sections [395], [397], [398], [815], [816], [817], [910], [911], [970], and [975]). To set the default code, go to section [398] on page 50 and refer to section [701] option [1] on page 50.
System Master Code (Default: 1234 / 123456)	The System Master code can use any arming method and can program user codes. To change the default code, go to section [399] on page 50 and refer to section [701] option [1] on page 50.

Panel Reset

Performing a panel reset will reset all programmable sections to factory default values.

SP4000 panels:

1. Verify installer lock is disabled.
2. Remove the battery and AC power from the control panel.
3. Remove all connected wires and devices from the PG1 and zone 1 terminals.
4. Short the PG1 and zone 1 terminals with a wire.
5. Reconnect the AC and battery power to the control panel.
6. Wait for 10 seconds and remove the wire.

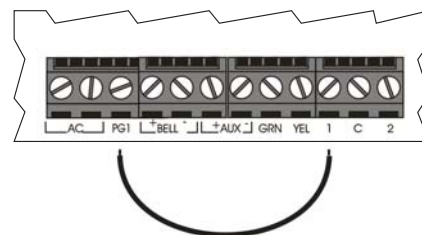

All other MG/SP panels:

To reset other MG/SP panels, press and hold the panel's **RESET** button until the STATUS LED flashes (5 seconds). Release the **RESET** button and push it again within 2 seconds. Performing a manual panel reset will not clear bus module troubles.

To reset the panel to default using section programming, see section [950] in *Important Settings and Modes* on page 6.

Viewing Version Numbers

Step	Action	Details	When Viewing Keypad Version
1.	Enter Viewing Mode: - For panel version , enter section [980]. - For keypad version , enter Installer Programming, then press and hold [ARM].	The first digit is displayed (usually "0")	Digit 1 ⇨ [ARM] is illuminated
2.	Press [ENTER]	The second digit is displayed	Digit 2 ⇨ [SLEEP] is illuminated
3.	Press [ENTER]	The third digit is displayed	Digit 3 ⇨ [STAY] is illuminated
4.	Press [ENTER]	The fourth digit is displayed	Digit 4 ⇨ [OFF] is illuminated

Example: Version **01.42**
 Digits 1-4

NOTE: K10V/H / K636 keypad version numbers cannot be viewed.

System Planning

Bus Module Planning

Use the following table to plan wired keypads, RTX3, RX1, ZX8 and ZX8SP modules.

Serial # Sticker	Description	Path Zone* (Entry Point)	Path Zone	Path Zone	Path Zone
Bus Module 1					
Bus Module 2					
Bus Module 3					
Bus Module 4					
Bus Module 5					
Bus Module 6					
Bus Module 7					
Bus Module 8					
Bus Module 9					
Bus Module 10					
Bus Module 11					
Bus Module 12					
Bus Module 13					
Bus Module 14					
Bus Module 15					

*Paths apply only to keypads in StayD mode.

Wireless Keypad Planning

Serial # Sticker	Description	Path Zone (Entry Point)	Path Zone	Path Zone	Path Zone
K32RF / K37 1					
K32RF / K37 2					
K32RF / K37 3					
K32RF / K37 4					
K32RF / K37 5					
K32RF / K37 6					
K32RF / K37 7					
K32RF / K37 8					

NOTE: When deleting a wireless keypad (K32RF / K37) from the system, the corresponding StayD path zones will also be deleted.

Wireless Siren Planning

Serial # Sticker	Description
Siren 1	
Siren 2	

Serial # Sticker	Description
Siren 3	
Siren 4	

PGM Planning

Serial # Sticker	Description
PGM 1	
PGM 2	
PGM 3	
PGM 4	
PGM 5	
PGM 6	
PGM 7	
PGM 8	

Serial # Sticker	Description
PGM 9	
PGM 10	
PGM 11	
PGM 12	
PGM 13	
PGM 14	
PGM 15	
PGM 16	

Wireless Repeater Planning

Serial # Sticker	Description
Repeater 1	

Serial # Sticker	Description
Repeater 2	

Zone Planning

Serial # Sticker	Zone#	Zone Description	Armed when...		
			Stay	Sleep	Full
Zone			<input type="checkbox"/>	<input type="checkbox"/>	<input type="checkbox"/>
Zone			<input type="checkbox"/>	<input type="checkbox"/>	<input type="checkbox"/>
Zone			<input type="checkbox"/>	<input type="checkbox"/>	<input type="checkbox"/>

Serial # Sticker	Zone#	Zone Description	Armed when...		
			Stay	Sleep	Full
Zone			<input type="checkbox"/>	<input type="checkbox"/>	<input type="checkbox"/>
Zone			<input type="checkbox"/>	<input type="checkbox"/>	<input type="checkbox"/>
Zone			<input type="checkbox"/>	<input type="checkbox"/>	<input type="checkbox"/>

Zone Programming See Quick Menus on page 65

NOTE: For keypad zone programming, see page 18.

Zone Recognition (MG Series)

When expanding zones via ZX8, up to 3 ZX8 modules can be added to the system and are identified by the ZX8 3-position jumpers +1, +9 and +17.

MG5000 No ATZ			MG5000 ATZ			MG5050 No ATZ			MG5050 ATZ		
Panel	Zone 1: Panel Input 1	Zone 2: Panel Input 2	Panel	Zone 1: Panel Input 1A	Zone 2: Panel Input 2A	Panel	Zone 1: Panel Input 1	Zone 2: Panel Input 2	Panel	Zone 1: Panel Input 1A	Zone 2: Panel Input 2A
ZX8 Jumper Panel + 1	Zone 3: Input 1	Zone 4: Input 2	ZX8 Jumper Panel + 1	Zone 3: Panel Input 1B	Zone 4: Panel Input 2B	ZX8 Jumper Panel + 1	Zone 3: Panel Input 3	Zone 4: Panel Input 4	ZX8 Jumper Panel + 1	Zone 3: Panel Input 3A	Zone 4: Panel Input 4A
ZX8 Jumper Panel + 9	Zone 5: Input 3	Zone 6: Input 4	ZX8 Jumper Panel + 9	Zone 5: Input 1	Zone 6: Input 2	ZX8 Jumper Panel + 9	Zone 5: Panel Input 5	Zone 6: Input 1	ZX8 Jumper Panel + 9	Zone 5: Panel Input 5A	Zone 6: Panel Input 1B
ZX8 Jumper Panel + 17	Zone 7: Input 5	Zone 8: Input 6	ZX8 Jumper Panel + 17	Zone 7: Input 3	Zone 8: Input 4	ZX8 Jumper Panel + 17	Zone 7: Input 5	Zone 7: Input 2	ZX8 Jumper Panel + 17	Zone 7: Panel Input 2B	Zone 8: Panel Input 3B
	Zone 9: Input 7	Zone 10: Input 8		Zone 9: Input 5	Zone 10: Input 6		Zone 8: Input 3	Zone 8: Input 3		Zone 8: Panel Input 3B	Zone 9: Panel Input 4B
	Zone 11: Input 1	Zone 12: Input 2		Zone 11: Input 7	Zone 12: Input 8		Zone 9: Input 4	Zone 9: Input 4		Zone 9: Panel Input 4B	Zone 10: Panel Input 5B
	Zone 13: Input 3	Zone 14: Input 4		Zone 13: Input 1	Zone 14: Input 2		Zone 10: Input 5	Zone 10: Input 5		Zone 11: Input 1	Zone 12: Input 2
	Zone 15: Input 5	Zone 16: Input 6		Zone 15: Input 3	Zone 16: Input 4		Zone 11: Input 6	Zone 11: Input 6		ZX8 Jumper Panel + 1	Zone 13: Input 3
	Zone 17: Input 7	Zone 18: Input 8		Zone 17: Input 5	Zone 18: Input 6		Zone 12: Input 7	Zone 12: Input 7		ZX8 Jumper Panel + 1	Zone 14: Input 4
	Zone 19: Input 1	Zone 20: Input 2		Zone 18: Input 6	Zone 19: Input 7		Zone 13: Input 8	Zone 13: Input 8		ZX8 Jumper Panel + 1	Zone 15: Input 5
	Zone 21: Input 3	Zone 22: Input 4		Zone 20: Input 8	Zone 21: Input 1		Zone 14: Input 1	Zone 14: Input 1		ZX8 Jumper Panel + 1	Zone 16: Input 6
	Zone 23: Input 5	Zone 24: Input 6		Zone 22: Input 2	Zone 23: Input 3		Zone 15: Input 2	Zone 15: Input 2		ZX8 Jumper Panel + 1	Zone 17: Input 7
	Zone 25: Input 7	Zone 26: Input 8		Zone 24: Input 4	Zone 25: Input 5		Zone 16: Input 3	Zone 16: Input 3		ZX8 Jumper Panel + 1	Zone 18: Input 8
	Zone 27: N/A	Zone 28: N/A		Zone 26: Input 6	Zone 27: Input 7		Zone 17: Input 4	Zone 17: Input 4		ZX8 Jumper Panel + 1	Zone 19: Input 1
	Zone 29: N/A	Zone 30: N/A		Zone 27: Input 7	Zone 28: Input 8		Zone 18: Input 5	Zone 18: Input 5		ZX8 Jumper Panel + 1	Zone 20: Input 2
	Zone 31: N/A	Zone 32: N/A		Zone 28: Input 8	Zone 29: N/A		Zone 19: Input 6	Zone 19: Input 6		ZX8 Jumper Panel + 1	Zone 21: Input 3
				Zone 29: N/A	Zone 30: N/A		Zone 20: Input 7	Zone 20: Input 7		ZX8 Jumper Panel + 1	Zone 22: Input 4
				Zone 30: N/A	Zone 31: N/A		Zone 21: Input 8	Zone 21: Input 8		ZX8 Jumper Panel + 1	Zone 23: Input 5
				Zone 31: N/A	Zone 32: N/A		Zone 22: Input 1	Zone 22: Input 1		ZX8 Jumper Panel + 1	Zone 24: Input 6
				Zone 32: N/A			Zone 23: Input 2	Zone 23: Input 2		ZX8 Jumper Panel + 1	Zone 25: Input 7
							Zone 24: Input 3	Zone 24: Input 3		ZX8 Jumper Panel + 1	Zone 26: Input 8
							Zone 25: Input 4	Zone 25: Input 4		ZX8 Jumper Panel + 1	Zone 27: Input 1
							Zone 26: Input 5	Zone 26: Input 5		ZX8 Jumper Panel + 1	Zone 28: Input 2
							Zone 27: Input 6	Zone 27: Input 6		ZX8 Jumper Panel + 1	Zone 29: Input 3
							Zone 28: Input 7	Zone 28: Input 7		ZX8 Jumper Panel + 1	Zone 30: Input 4
							Zone 29: Input 8	Zone 29: Input 8		ZX8 Jumper Panel + 1	Zone 31: Input 5
							Zone 30: N/A	Zone 30: N/A		ZX8 Jumper Panel + 1	Zone 32: Input 6
							Zone 31: N/A	Zone 31: N/A			
							Zone 32: N/A	Zone 32: N/A			

NOTE: If a zone is already programmed and you assign a device to the same zone, a wireless zone will overwrite a keypad/hardware zone, and a keypad zone will overwrite a hardware zone.

Zone Recognition (SP Series)

When expanding zones via ZX8, up to 3 ZX8 modules can be added to the system and are identified by the ZX8 3-position jumpers +1, +9 and +17.

SP4000 No ATZ			SP4000 ATZ			SP5500 No ATZ			SP5500 ATZ		
Panel	Zone 1: Panel Input 1	Zone 2: Panel Input 2	Panel	Zone 1: Panel Input 1A	Zone 2: Panel Input 2A	Panel	Zone 1: Panel Input 1	Zone 2: Panel Input 2	Panel	Zone 1: Panel Input 1A	Zone 2: Panel Input 2A
ZX8 Jumper Panel + 1	Zone 3: Panel Input 3	Zone 4: Panel Input 4	ZX8 Jumper Panel + 1	Zone 3: Panel Input 3A	Zone 4: Panel Input 4A	ZX8 Jumper Panel + 1	Zone 3: Panel Input 3	Zone 4: Panel Input 4	ZX8 Jumper Panel + 1	Zone 3: Panel Input 3A	Zone 4: Panel Input 4A
ZX8 Jumper Panel + 9	Zone 5: Input 1	Zone 6: Input 2	ZX8 Jumper Panel + 9	Zone 5: Panel Input 1B	Zone 6: Panel Input 2B	ZX8 Jumper Panel + 9	Zone 5: Panel Input 5	Zone 6: Input 1	ZX8 Jumper Panel + 9	Zone 5: Panel Input 5A	Zone 6: Panel Input 1B
ZX8 Jumper Panel + 17	Zone 7: Input 3	Zone 8: Input 4	ZX8 Jumper Panel + 17	Zone 7: Panel Input 3B	Zone 8: Panel Input 4B	ZX8 Jumper Panel + 17	Zone 7: Input 3	Zone 7: Input 2	ZX8 Jumper Panel + 17	Zone 7: Panel Input 2B	Zone 8: Panel Input 3B
	Zone 9: Input 5	Zone 10: Input 6		Zone 9: Input 1	Zone 10: Input 2		Zone 8: Input 4	Zone 8: Input 3		Zone 8: Panel Input 3B	Zone 9: Panel Input 4B
	Zone 11: Input 7	Zone 12: Input 8		Zone 11: Input 3	Zone 12: Input 4		Zone 9: Input 5	Zone 9: Input 4		Zone 9: Panel Input 4B	Zone 10: Panel Input 5B
	Zone 13: Input 1	Zone 14: Input 2		Zone 13: Input 5	Zone 14: Input 6		Zone 10: Input 6	Zone 10: Input 5		Zone 11: Input 1	Zone 12: Input 2
	Zone 15: Input 3	Zone 16: Input 4		Zone 15: Input 7	Zone 16: Input 8		Zone 11: Input 6	Zone 11: Input 6		ZX8 Jumper Panel + 1	Zone 13: Input 3
	Zone 17: Input 5			Zone 17: Input 1			Zone 12: Input 7	Zone 12: Input 7		ZX8 Jumper Panel + 1	Zone 14: Input 4
							Zone 13: Input 8	Zone 13: Input 8		ZX8 Jumper Panel + 1	Zone 15: Input 5
							Zone 14: Input 1	Zone 14: Input 1		ZX8 Jumper Panel + 1	Zone 16: Input 6
							Zone 15: Input 2	Zone 15: Input 2		ZX8 Jumper Panel + 1	Zone 17: Input 7
							Zone 16: Input 3	Zone 16: Input 3			
							Zone 17: Input 4	Zone 17: Input 4			

SP4000 No ATZ	SP4000 ATZ
Zone 18: Input 6 Zone 19: Input 7 Zone 20: Input 8	Zone 18: Input 2 ZX8 Zone 19: Input 3 Jumper Zone 20: Input 4
ZX8 Zone 21: Input 1 Jumper Zone 22: Input 2 Panel + 17 Zone 23: Input 3 Zone 24: Input 4 Zone 25: Input 5 Zone 26: Input 6 Zone 27: Input 7 Zone 28: Input 8	Panel + 9 Zone 21: Input 5 Zone 22: Input 6 Zone 23: Input 7 Zone 24: Input 8
Zone 29: N/A Zone 30: N/A Zone 31: N/A Zone 32: N/A	Zone 25: Input 1 Zone 26: Input 2 ZX8 Zone 27: Input 3 Jumper Zone 28: Input 4 Panel + 17 Zone 29: Input 5 Zone 30: Input 6 Zone 31: Input 7 Zone 32: Input 8

SP5500 No ATZ	SP5500 ATZ
Panel + 9 Zone 18: Input 5 Zone 19: Input 6 Zone 20: Input 7 Zone 21: Input 8	Zone 18: Input 8 Zone 19: Input 1 Zone 20: Input 2 Zone 21: Input 3
ZX8 Zone 22: Input 1 Jumper Zone 23: Input 2 Panel + 17 Zone 24: Input 3 Zone 25: Input 4 Zone 26: Input 5 Zone 27: Input 6 Zone 28: Input 7 Zone 29: Input 8	ZX8 Zone 22: Input 4 Jumper Zone 23: Input 5 Panel + 9 Zone 24: Input 6 Zone 25: Input 7 Zone 26: Input 8
Zone 30: N/A Zone 31: N/A Zone 32: N/A	Zone 27: Input 1 ZX8 Zone 28: Input 2 Jumper Zone 29: Input 3 Panel + 17 Zone 30: Input 4 Zone 31: Input 5 Zone 32: Input 6

NOTE: If a zone is already programmed and you assign a device to the same zone, a wireless zone will overwrite a keypad/hardwire zone, and a keypad zone will overwrite a hardwire zone.

SP6000 No ATZ	SP6000 ATZ
Panel Zone 1: Panel Input 1 Zone 2: Panel Input 2 Zone 3: Panel Input 3 Zone 4: Panel Input 4 Zone 5: Panel Input 5 Zone 6: Panel Input 6 Zone 7: Panel Input 7 Zone 8: Panel Input 8	Panel Zone 1: Panel Input 1A Zone 2: Panel Input 2A Zone 3: Panel Input 3A Zone 4: Panel Input 4A Zone 5: Panel Input 5A Zone 6: Panel Input 6A Zone 7: Panel Input 7A Zone 8: Panel Input 8A
ZX8 Zone 9: Input 1 Jumper Zone 10: Input 2 Panel + 1 Zone 11: Input 3 Zone 12: Input 4 Zone 13: Input 5 Zone 14: Input 6 Zone 15: Input 7 Zone 16: Input 8	Zone 9: Panel Input 1B Zone 10: Panel Input 2B Zone 11: Panel Input 3B Zone 12: Panel Input 4B Zone 13: Panel Input 5B Zone 14: Panel Input 6B Zone 15: Panel Input 7B Zone 16: Panel Input 8B
ZX8 Zone 17: Input 1 Jumper Zone 18: Input 2 Panel + 9 Zone 19: Input 3 Zone 20: Input 4 Zone 21: Input 5 Zone 22: Input 6 Zone 23: Input 7 Zone 24: Input 8	ZX8 Zone 17: Input 1 Jumper Zone 18: Input 2 Panel + 1 Zone 19: Input 3 Zone 20: Input 4 Zone 21: Input 5 Zone 22: Input 6 Zone 23: Input 7 Zone 24: Input 8
ZX8 Zone 25: Input 1 Jumper Zone 26: Input 2 Panel + 17 Zone 27: Input 3 Zone 28: Input 4 Zone 29: Input 5 Zone 30: Input 6 Zone 31: Input 7 Zone 32: Input 8	ZX8 Zone 25: Input 1 Jumper Zone 26: Input 2 Panel + 9 Zone 27: Input 3 Zone 28: Input 4 Zone 29: Input 5 Zone 30: Input 6 Zone 31: Input 7 Zone 32: Input 8

SP7000 No ATZ	SP7000 ATZ
Panel Zone 1: Panel Input 1 Zone 2: Panel Input 2 Zone 3: Panel Input 3 Zone 4: Panel Input 4 Zone 5: Panel Input 5 Zone 6: Panel Input 6 Zone 7: Panel Input 7 Zone 8: Panel Input 8 Zone 9: Panel Input 9 Zone 10: Panel Input 10 Zone 11: Panel Input 11 Zone 12: Panel Input 12 Zone 13: Panel Input 13 Zone 14: Panel Input 14 Zone 15: Panel Input 15 Zone 16: Panel Input 16	Zone 1: Panel Input 1A Zone 2: Panel Input 2A Zone 3: Panel Input 3A Zone 4: Panel Input 4A Zone 5: Panel Input 5A Zone 6: Panel Input 6A Zone 7: Panel Input 7A Zone 8: Panel Input 8A Zone 9: Panel Input 9A Zone 10: Panel Input 10A Zone 11: Panel Input 11A Zone 12: Panel Input 12A Zone 13: Panel Input 13A Zone 14: Panel Input 14A Zone 15: Panel Input 15A Panel Zone 16: Panel Input 16A
ZX8 Zone 17: Input 1 Jumper Zone 18: Input 2 Panel + 1 Zone 19: Input 3 Zone 20: Input 4 Zone 21: Input 5 Zone 22: Input 6 Zone 23: Input 7 Zone 24: Input 8	Zone 17: Panel Input 1B Zone 18: Panel Input 2B Zone 19: Panel Input 3B Zone 20: Panel Input 4B Zone 21: Panel Input 5B Zone 22: Panel Input 6B Zone 23: Panel Input 7B Zone 24: Panel Input 8B
ZX8 Zone 25: Input 1 Jumper Zone 26: Input 2 Panel + 9 Zone 27: Input 3 Zone 28: Input 4 Zone 29: Input 5 Zone 30: Input 6 Zone 31: Input 7 Zone 32: Input 8	Zone 25: Panel Input 9B Zone 26: Panel Input 10B Zone 27: Panel Input 11B Zone 28: Panel Input 12B Zone 29: Panel Input 13B Zone 30: Panel Input 14B Zone 31: Panel Input 15B Zone 32: Panel Input 16B

Zone Definitions

NOTE: If a zone is already programmed and you assign a device to the same zone, a wireless zone will overwrite a keypad/hardware zone, and a keypad zone will overwrite a hardware zone.

To program zone definitions, zone partitions and assign options:

Step	Action	Details
1	[ENTER] + [INSTALLER CODE] (default: 0000 / 000000)	[ARM] + [STAY] = flash. [MAINTENANCE CODE] may also be used.
2	Enter 3-digit zone you wish to program [001] to [032]	[ARM] + [STAY] = on (see table on page 15)
3	Enter a 2-digit zone definition	2 digits: 01 to 32 (see <i>Zone Definitions</i> table on page 14)
4	Assign Partition [1], [2] or [3]	By default, all zones are assigned to partition 1. (see <i>Partition Assignment</i> table on page 14).
5	Select or deselect zone options using buttons [1] to [8]	<i>Zone Options</i> - see Zone Options table on page 14. ON = feature activated OFF = feature deactivated <i>Keyswitch Options</i> - see Keyswitch Options table on page 14.
6	To save and proceed to the next zone, press [ENTER]	

Table 1: Zone Definitions

Zone Definitions	Stay Arm	Sleep Arm	Fully Arm	Zone Definitions
00 = Zone Disabled (default)	-	-	-	11 = Instant Fire†
01 = Entry Delay 1	Entry Delay 1	Entry Delay 1	Entry Delay 1	12 = Delayed Fire†
02 = Entry Delay 2	Entry Delay 2	Entry Delay 2	Entry Delay 2	13 = Instant Fire Silent†
03 = Entry Delay 1 (Full Arm)	Not Armed	Not Armed	Entry Delay 1	14 = Delayed Fire Silent†
04 = Entry Delay2 (Full Arm)	Not Armed	Not Armed	Entry Delay 2	15 = 24Hr. Buzzer
05 = Follow	Follow*	Follow*	Follow	16 = 24Hr. Burglary
06 = Follow (Sleep/Full Arm)	Not Armed	Follow*	Follow	17 = 24Hr. Hold-up
07 = Follow (Full Arm)	Not Armed	Not Armed	Follow	18 = 24Hr. Gas
08 = Instant	Instant*	Instant*	Instant	19 = 24Hr. Heat
09 = Instant (Sleep/Full Arm)	Not Armed	Instant*	Instant	20 = 24Hr. Water
10 = Instant (Full Arm)	Not Armed	Not Armed	Instant	21 = 24Hr. Freeze
				22 = 24hr. Panic††
33 = Instant No Pre-Alarm (Stay/Sleep)	Instant	Instant	Not Armed	23 = Follow No Pre-Alarm
34 = Instant No Pre-Alarm (Sleep)	Not Armed	Instant	Not Armed	24 = Instant No Pre-Alarm
35 = Entry Delay 1 (Stay/Full) / Instant	Entry Delay 1	Instant	Entry Delay 1	25 = Keyswitch Maintain**
36 = Entry Delay 1 (Full Arm) / Instant	Instant	Instant	Entry Delay 1	26 = Keyswitch Momentary**

* Flex-Instant = Zone will follow the delay at section [720], (default is 15 seconds / 0 = instant zone)
 ** On-board hardware control panel zones only
 † ZX8 inputs do not support fire zones.
 For 2-wire smoke installations (not supported by SP4000 / SP5500), these definitions apply to Zone 1 Input only. Section [706], option [3] must be enabled.
 For 4-wire smoke installations, use any panel on-board zone input.
 †† This alarm will follow the Panic 1 option (section [702], option [1])

NOTE: For more zone options, see sections [705] and [706] on page 16.

Table 2: Partition Assignment

[1]- Partition 1†
[2]- Partition 2†
[3]- Both partitions†
† When using a K636 keypad, only partition 1 is available.

Table 3: Zone Options

[1] = Auto-zone Shutdown
[2] = Bypassable Zone
[3] = RF Zone Supervision
[4] [5]
OFF OFF Audible Alarm
OFF ON Pulsed Alarm
ON OFF Silent Alarm
ON ON Report Only
[6] = Intellizone
[7] = Delay alarm transmission
[8] = Force Zone

Table 4: Keyswitch Options

[1]- N/A
[2]- N/A
[3]- N/A
[4] OFF = Disarm
ON = Disarm only if Stay/Sleep armed
[5] = Arm only
[6] = Stay arming‡
[7] = Sleep arming‡
[8] = N/A
‡ Select only one. If all are off, keyswitch will regular arm.

Custom Zone Definitions

Create up to four custom zone definition templates* (custom zone definition templates [033] to [036] will overwrite zone definitions 33 to 36, refer to the *Zone Definitions* table on page 14). Modifications can be made according to the *Permitted Zone Definitions* table below.

Section		Disarm	Stay Arm	Sleep Arm	Full Arm
[033]	Zone Definition Template 1	___/___	___/___	___/___	___/___
[034]	Zone Definition Template 2	___/___	___/___	___/___	___/___
[035]	Zone Definition Template 3	___/___	___/___	___/___	___/___
[036]	Zone Definition Template 4	___/___	___/___	___/___	___/___

* This feature is not available on SP4000 systems.

Table 5: Permitted Zone Definitions

Zone Definitions	Disarm	Stay Arm	Sleep Arm	Fully Arm	Zone Definitions	Disarm	Stay Arm	Sleep Arm	Fully Arm
00 = Zone Disabled	✓	✓	✓	✓	13 = Instant Fire Silent	✓	✓	✓	✓
01 = Entry Delay 1	-	✓	✓	✓	14 = Delayed Fire Silent	✓	✓	✓	✓
02 = Entry Delay 2	-	✓	✓	✓	15 = 24Hr. Buzzer	✓	✓	✓	✓
03 = Entry Delay 1 (Full Arm)	-	-	-	✓	16 = 24Hr. Burglary	✓	✓	✓	✓
04 = Entry Delay2 (Full Arm)	-	-	-	✓	17 = 24Hr. Hold-up	✓	✓	✓	✓
05 = Follow	-	✓	✓	✓	18 = 24Hr. Gas	✓	✓	✓	✓
06 = Follow (Sleep/Full Arm)	-	-	✓	✓	19 = 24Hr. Heat	✓	✓	✓	✓
07 = Follow (Full Arm)	-	-	-	✓	20 = 24Hr. Water	✓	✓	✓	✓
08 = Instant	-	✓	✓	✓	21 = 24Hr. Freeze	✓	✓	✓	✓
09 = Instant (Sleep/Full Arm)	-	-	✓	✓	22 = 24hr. Panic	✓	✓	✓	✓
10 = Instant (Full Arm)	-	-	-	✓	23 = Follow No Pre-Alarm	-	✓	✓	✓
11 = Instant Fire	✓	✓	✓	✓	24 = Instant No Pre-Alarm	-	✓	✓	✓
12 = Delayed Fire	✓	✓	✓	✓					

Section	Zone*	Zone Definition	Partition	Zone Options	Section	Wireless SN or press tamper/learn. To delete, enter 000000
[001]	Zone 1:	___/___	___	1 2 3 4 5 6 7 8	[061]	___/___/___/___/___/___
[002]	Zone 2:	___/___	___	1 2 3 4 5 6 7 8	[062]	___/___/___/___/___/___
[003]	Zone 3:	___/___	___	1 2 3 4 5 6 7 8	[063]	___/___/___/___/___/___
[004]	Zone 4:	___/___	___	1 2 3 4 5 6 7 8	[064]	___/___/___/___/___/___
[005]	Zone 5:	___/___	___	1 2 3 4 5 6 7 8	[065]	___/___/___/___/___/___
[006]	Zone 6:	___/___	___	1 2 3 4 5 6 7 8	[066]	___/___/___/___/___/___
[007]	Zone 7:	___/___	___	1 2 3 4 5 6 7 8	[067]	___/___/___/___/___/___
[008]	Zone 8:	___/___	___	1 2 3 4 5 6 7 8	[068]	___/___/___/___/___/___
[009]	Zone 9:	___/___	___	1 2 3 4 5 6 7 8	[069]	___/___/___/___/___/___
[010]	Zone 10:	___/___	___	1 2 3 4 5 6 7 8	[070]	___/___/___/___/___/___
[011]	Zone 11:	___/___	___	1 2 3 4 5 6 7 8	[071]	___/___/___/___/___/___
[012]	Zone 12:	___/___	___	1 2 3 4 5 6 7 8	[072]	___/___/___/___/___/___
[013]	Zone 13:	___/___	___	1 2 3 4 5 6 7 8	[073]	___/___/___/___/___/___
[014]	Zone 14:	___/___	___	1 2 3 4 5 6 7 8	[074]	___/___/___/___/___/___
[015]	Zone 15:	___/___	___	1 2 3 4 5 6 7 8	[075]	___/___/___/___/___/___
[016]	Zone 16:	___/___	___	1 2 3 4 5 6 7 8	[076]	___/___/___/___/___/___
[017]	Zone 17:	___/___	___	1 2 3 4 5 6 7 8	[077]	___/___/___/___/___/___
[018]	Zone 18:	___/___	___	1 2 3 4 5 6 7 8	[078]	___/___/___/___/___/___
[019]	Zone 19:	___/___	___	1 2 3 4 5 6 7 8	[079]	___/___/___/___/___/___
[020]	Zone 20:	___/___	___	1 2 3 4 5 6 7 8	[080]	___/___/___/___/___/___
[021]	Zone 21:	___/___	___	1 2 3 4 5 6 7 8	[081]	___/___/___/___/___/___
[022]	Zone 22:	___/___	___	1 2 3 4 5 6 7 8	[082]	___/___/___/___/___/___
[023]	Zone 23:	___/___	___	1 2 3 4 5 6 7 8	[083]	___/___/___/___/___/___
[024]	Zone 24:	___/___	___	1 2 3 4 5 6 7 8	[084]	___/___/___/___/___/___
[025]	Zone 25:	___/___	___	1 2 3 4 5 6 7 8	[085]	___/___/___/___/___/___
[026]	Zone 26:	___/___	___	1 2 3 4 5 6 7 8	[086]	___/___/___/___/___/___
[027]	Zone 27:	___/___	___	1 2 3 4 5 6 7 8	[087]	___/___/___/___/___/___
[028]	Zone 28:	___/___	___	1 2 3 4 5 6 7 8	[088]	___/___/___/___/___/___
[029]	Zone 29:	___/___	___	1 2 3 4 5 6 7 8	[089]	___/___/___/___/___/___
[030]	Zone 30:	___/___	___	1 2 3 4 5 6 7 8	[090]	___/___/___/___/___/___
[031]	Zone 31:	___/___	___	1 2 3 4 5 6 7 8	[091]	___/___/___/___/___/___
[032]	Zone 32:	___/___	___	1 2 3 4 5 6 7 8	[092]	___/___/___/___/___/___

 Refer to the **Installer Quick Menu** on page 65.

* See Zone Recognition tables on page 12.

Zone Labels

[965] Reset Zone Labels

Option

[1] Reset zone labels*

OFF

Disabled

ON

Enabled

* Ensure all other options are deselected. Press [ENTER] to reset the respective set of labels to default before exiting the section.

Section	Zone Label	Section	Zone Label
[181]	1	[197]	17
[182]	2	[198]	18
[183]	3	[199]	19
[184]	4	[200]	20
[185]	5	[201]	21
[186]	6	[202]	22
[187]	7	[203]	23
[188]	8	[204]	24
[189]	9	[205]	25
[190]	10	[206]	26
[191]	11	[207]	27
[192]	12	[208]	28
[193]	13	[209]	29
[194]	14	[210]	30
[195]	15	[211]	31
[196]	16	[212]	32

NOTE: For label character tables, see *LCD Keypad Labels (K32LCD)* on page 47.

Bus Module Labels

[965] Reset Bus Module Labels

Option

[5] Reset bus module labels*

OFF

Disabled

ON

Enabled

* Ensure all other options are deselected. Enable all options you want to reset to default. Press [ENTER] to reset the respective set of report codes to default before exiting the section.

Section	Bus	Label	Section	Bus	Label
[781]	1		[789]	9	
[782]	2		[790]	10	
[783]	3		[791]	11	
[784]	4		[792]	12	
[785]	5		[793]	13	
[786]	6		[794]	14	
[787]	7		[795]	15	
[788]	8				

NOTE: For label character tables, see *LCD Keypad Labels (K32LCD)* on page 47.

Zone Options

[705] ATZ Options

Option

[1] ATZ zone doubling

[2] ATZ wiring options

[3] & [4] Tamper Recognition

OFF

Disabled

Series

ON

Enabled

Parallel

[3]	[4]	RF Zone/Hardwired Zone Tamper Recognition Options	Keypad / Bus Module Tamper Recognition Options*
OFF	OFF	Disabled	Disabled
OFF	ON	Trouble only	Trouble only
ON	OFF	When disarmed: Trouble only When armed: Follow zone's alarm type	Trouble only
ON	ON	When disarmed: Audible alarm When armed: Follow zone's alarm type	Audible alarm

* Tamper recognition of keypad / bus module only if section [700] option [7] is enabled.

[5] Generate tamper on bypassed zone

No

Yes

[6] & [7] Supervision Options

[6]	[7]	RF Zone Supervision Options (except SP4000)	Keypad / Bus Module Supervision Options
OFF	OFF	Disabled	Disabled
OFF	ON	Trouble only	Trouble only
ON	OFF	When disarmed: Trouble only When armed: Follow zone's alarm type	Trouble only
ON	ON	When disarmed: audible alarm When armed: Follow zone's alarm type	Trouble only

[8] Generate supervision on bypassed zone No Yes

[706] General Zone Options

Option	OFF	ON
[1] Check-in supervision time (except SP4000)	<input type="checkbox"/> 24 hours	<input type="checkbox"/> 80 minutes
[2] EOL resistors*	<input type="checkbox"/> Disabled	<input type="checkbox"/> Enabled
[3] Zone Input 1 becomes a 2-wire smoke input (except SP5500/SP4000)	<input type="checkbox"/> Disabled	<input type="checkbox"/> Enabled
[4] ZX8 ID A (Panel + 1) Input 1	<input type="checkbox"/> Zone input	<input type="checkbox"/> Tamper input
[5] ZX8 ID B (Panel + 9) Input 1	<input type="checkbox"/> Zone input	<input type="checkbox"/> Tamper input
[6] ZX8 ID C (Panel + 17) Input 1	<input type="checkbox"/> Zone input	<input type="checkbox"/> Tamper input

*This option applies to all hardwired zones (panel, keypad, ZX8)

Zone Timers (MG Series)

Note that When both ATZ and EOL are enabled, zone speed should not be set below 300ms.

Section	MG5000	MG5050	Data	Description (Default 060)
[041] Zone 1	(Z1)	(Z1)	___/___/___ (000 to 255) x 10ms	Hardwire Zone 1 Speed
[042] Zone 2	(Z2)	(Z2)	___/___/___ (000 to 255) x 10ms	Hardwire Zone 2 Speed
[043] Zone 3	(Z1 ATZ)	(Z3)	___/___/___ (000 to 255) x 10ms	Hardwire Zone 3 Speed
[044] Zone 4	(Z2 ATZ)	(Z4)	___/___/___ (000 to 255) x 10ms	Hardwire Zone 4 Speed
[045] Zone 5		(Z5)	___/___/___ (000 to 255) x 10ms	Hardwire Zone 5 Speed
[046] Zone 6		(Z1 ATZ)	___/___/___ (000 to 255) x 10ms	Hardwire Zone 6 Speed
[047] Zone 7		(Z2 ATZ)	___/___/___ (000 to 255) x 10ms	Hardwire Zone 7 Speed
[048] Zone 8		(Z3 ATZ)	___/___/___ (000 to 255) x 10ms	Hardwire Zone 8 Speed
[049] Zone 9		(Z4 ATZ)	___/___/___ (000 to 255) x 10ms	Hardwire Zone 9 Speed
[050] Zone 10		(Z5 ATZ)	___/___/___ (000 to 255) x 10ms	Hardwire Zone 10 Speed
[051] Zone 11			___/___/___ (000 to 255) x 10ms	Hardwire Zone 11 Speed
[052] Zone 12			___/___/___ (000 to 255) x 10ms	Hardwire Zone 12 Speed
[053] Zone 13			___/___/___ (000 to 255) x 10ms	Hardwire Zone 13 Speed
[054] Zone 14			___/___/___ (000 to 255) x 10ms	Hardwire Zone 14 Speed
[055] Zone 15			___/___/___ (000 to 255) x 10ms	Hardwire Zone 15 Speed
[056] Zone 16			___/___/___ (000 to 255) x 10ms	Hardwire Zone 16 Speed

Zone Timers (SP Series)

NOTE: When both ATZ and EOL are enabled, zone speed should not be set below 300ms.

Section	SP4000	SP5500	SP6000	SP7000*	Data	Description (Default 060)
[041] Zone 1	(Z1)	(Z1)	(Z1)	(Z1)	___/___/___ (000 to 255) x 10ms	Hardwire Zone 1 Speed
[042] Zone 2	(Z2)	(Z2)	(Z2)	(Z2)	___/___/___ (000 to 255) x 10ms	Hardwire Zone 2 Speed
[043] Zone 3	(Z3)	(Z3)	(Z3)	(Z3)	___/___/___ (000 to 255) x 10ms	Hardwire Zone 3 Speed
[044] Zone 4	(Z4)	(Z4)	(Z4)	(Z4)	___/___/___ (000 to 255) x 10ms	Hardwire Zone 4 Speed
[045] Zone 5	(Z1 ATZ)	(Z5)	(Z5)	(Z5)	___/___/___ (000 to 255) x 10ms	Hardwire Zone 5 Speed
[046] Zone 6	(Z2 ATZ)	(Z1 ATZ)	(Z6)	(Z6)	___/___/___ (000 to 255) x 10ms	Hardwire Zone 6 Speed
[047] Zone 7	(Z3 ATZ)	(Z2 ATZ)	(Z7)	(Z7)	___/___/___ (000 to 255) x 10ms	Hardwire Zone 7 Speed
[048] Zone 8	(Z4 ATZ)	(Z3 ATZ)	(Z8)	(Z8)	___/___/___ (000 to 255) x 10ms	Hardwire Zone 8 Speed
[049] Zone 9		(Z4 ATZ)	(Z1 ATZ)	(Z9)	___/___/___ (000 to 255) x 10ms	Hardwire Zone 9 Speed
[050] Zone 10		(Z5 ATZ)	(Z2 ATZ)	(Z10)	___/___/___ (000 to 255) x 10ms	Hardwire Zone 10 Speed
[051] Zone 11			(Z3 ATZ)	(Z11)	___/___/___ (000 to 255) x 10ms	Hardwire Zone 11 Speed
[052] Zone 12			(Z4 ATZ)	(Z12)	___/___/___ (000 to 255) x 10ms	Hardwire Zone 12 Speed
[053] Zone 13			(Z5 ATZ)	(Z13)	___/___/___ (000 to 255) x 10ms	Hardwire Zone 13 Speed
[054] Zone 14			(Z6 ATZ)	(Z14)	___/___/___ (000 to 255) x 10ms	Hardwire Zone 14 Speed
[055] Zone 15			(Z7 ATZ)	(Z15)	___/___/___ (000 to 255) x 10ms	Hardwire Zone 15 Speed
[056] Zone 16			(Z8 ATZ)	(Z16)	___/___/___ (000 to 255) x 10ms	Hardwire Zone 16 Speed

* SP7000: For zones 17-32 (ATZ), the zone timer is set at 0.6 seconds.

Zone Report Codes (Default = FF)

[966] Clear Zone Report Codes

Option OFF Disabled ON Enabled
 [1] Clear zone report codes*

* Ensure all other options are deselected. Press [ENTER] to clear the respective set of report codes before exiting the section.

[967] Reset Zone Report Codes

Option OFF Disabled ON Enabled
 [1] Reset zone report codes to default*

* Ensure all other options are deselected. Press [ENTER] to reset the respective set of report codes before exiting the section.

Section	Alarm	Alarm Restore	Tamper	Tamper Restore	Section	Alarm	Alarm Restore	Tamper	Tamper Restore
[141]	Zone 1:	__/_	__/_	__/_	[157]	Zone 17:	__/_	__/_	__/_
[142]	Zone 2:	__/_	__/_	__/_	[158]	Zone 18:	__/_	__/_	__/_
[143]	Zone 3:	__/_	__/_	__/_	[159]	Zone 19:	__/_	__/_	__/_
[144]	Zone 4:	__/_	__/_	__/_	[160]	Zone 20:	__/_	__/_	__/_
[145]	Zone 5:	__/_	__/_	__/_	[161]	Zone 21:	__/_	__/_	__/_
[146]	Zone 6:	__/_	__/_	__/_	[162]	Zone 22:	__/_	__/_	__/_
[147]	Zone 7:	__/_	__/_	__/_	[163]	Zone 23:	__/_	__/_	__/_
[148]	Zone 8:	__/_	__/_	__/_	[164]	Zone 24:	__/_	__/_	__/_
[149]	Zone 9:	__/_	__/_	__/_	[165]	Zone 25:	__/_	__/_	__/_
[150]	Zone 10:	__/_	__/_	__/_	[166]	Zone 26:	__/_	__/_	__/_
[151]	Zone 11:	__/_	__/_	__/_	[167]	Zone 27:	__/_	__/_	__/_
[152]	Zone 12:	__/_	__/_	__/_	[168]	Zone 28:	__/_	__/_	__/_
[153]	Zone 13:	__/_	__/_	__/_	[169]	Zone 29:	__/_	__/_	__/_
[154]	Zone 14:	__/_	__/_	__/_	[170]	Zone 30:	__/_	__/_	__/_
[155]	Zone 15:	__/_	__/_	__/_	[171]	Zone 31:	__/_	__/_	__/_
[156]	Zone 16:	__/_	__/_	__/_	[172]	Zone 32:	__/_	__/_	__/_

Keypad Programming

Keypad Zone Number Assignment

Step	Action	Details
1	[ENTER] + [INSTALLER CODE] (default: 0000 / 000000)	[ARM] + [STAY] = flash. [MAINTENANCE CODE] may also be used.
2	Press and hold  (3sec)	[ARM] + [STAY] = on.
3	[ZONE NUMBER] + [ENTER]	K35 / K32 / K32LCD = 2 digits: 01 to 32. K636 / K10V/H = 1 digit: 1 to 0 (10). To erase a keypad zone number, press [CLEAR], then [ENTER].

Entry Point Zone Assignment (StayD)

Step	Action	Details
1	[ENTER] + [INSTALLER CODE] (default: 0000 / 000000)	[ARM] + [STAY] = flash.
2	Press and hold [OFF] (3sec)	[ARM] + [STAY] = on.
3	[ZONE NUMBER]	K35 / K32RF / K37 / K32 / K32LCD = 2 digits: 01 to 32. K636 / K10V/H = 1 digit: 1 to 0(10) (maximum 10 zones). The first zone you program will be the designated entry point and will flash. Up to three more path zones can be added; these zones will light up and stay lit.
4	[ENTER]	Press [ENTER] to save and exit.

Keypad Input/Output Configuration (K636 V2.0 and higher)

Step	Action	Details
1	[ENTER] + [INSTALLER CODE] (default: 0000 / 000000)	[ARM] + [STAY] = flash.
2	Press and hold [ENTER] (3sec)	[ARM] + [STAY] = on.
3	Option [1]	ON = Output switches to ground following system arming (Blue wire 150mA max.). OFF = Input (Keypad zone input).
4	Option [2]	ON = Output N.C. OFF = Output N.O.

NOTE: When configuring as an output, you must first clear the keypad zone (if assigned).

[742] Partition 2 Options

Option		OFF	ON
[1]	Auto-arm on time	<input type="checkbox"/> Disabled	<input type="checkbox"/> Enabled
[2]	Auto-arm on no movement	<input type="checkbox"/> Disabled	<input type="checkbox"/> Enabled
	Auto-arm arming mode	<input type="checkbox"/> See Table	<input type="checkbox"/> See Table
[3]&[4]			
		[3] OFF	[4] OFF Regular
		OFF	ON Sleep
		ON	OFF Stay
[5]	Switch to stay arming if no entry delay zone is opened	<input type="checkbox"/> Disabled	<input type="checkbox"/> Enabled
[6]	Follow zones become entry delay 2 when delay zone is bypassed	<input type="checkbox"/> Disabled	<input type="checkbox"/> Enabled

Partition Timers



Refer to the *Installer Quick Menu* on page 65 for alternate entry/exit and bell cut-off timer programming.

Section	Data	Description
[745]	___/___/___	(000 to 255) seconds Partition 1 exit delay (default 060)
[746]	___/___/___	(000 to 255) seconds Partition 2 exit delay (default 060)
[747]	___/___/___	(000 to 255) minutes Partition 1 bell cut-off (default 004)
[748]	___/___/___	(000 to 255) minutes Partition 2 bell cut-off (default 004)
[749]	___/___/___	(000 to 255) x 15 minutes Partition 1 no movement (default 000)
[750]	___/___/___	(000 to 255) x 15 minutes Partition 2 no movement (default 000)
[761]	___/___:___/___	HH: MM Auto-arm on time Partition 1 (default 00:00)
[762]	___/___:___/___	HH: MM Auto-arm on time Partition 2 (default 00:00)

System Programming

[700] General System Options

Option		OFF	ON
[2]	Battery charging (350mA or 700mA)*	<input type="checkbox"/> 350mA	<input type="checkbox"/> 700mA
[3]	Audible trouble warning (except AC failure)	<input type="checkbox"/> Disabled	<input type="checkbox"/> Enabled
[4]	Audible trouble warning on AC failure	<input type="checkbox"/> Disabled	<input type="checkbox"/> Enabled
[6]	Exit delay termination	<input type="checkbox"/> Disabled	<input type="checkbox"/> Enabled
[7]	Tamper supervision on the bus module	<input type="checkbox"/> Disabled	<input type="checkbox"/> Enabled

* Does not apply to SP4000 systems

[702] Panic Options

Option		OFF	ON
[1]	Panic 1	<input type="checkbox"/> Disabled	<input type="checkbox"/> Enabled
[2]	Panic 2	<input type="checkbox"/> Disabled	<input type="checkbox"/> Enabled
[3]	Panic 3	<input type="checkbox"/> Disabled	<input type="checkbox"/> Enabled
[4]	Panic 1: Report only or audible alarm	<input type="checkbox"/> Report only	<input type="checkbox"/> Audible
[5]	Panic 2: Report only or audible alarm	<input type="checkbox"/> Report only	<input type="checkbox"/> Audible
[6]	Panic 3: Report only or audible alarm	<input type="checkbox"/> Report only	<input type="checkbox"/> Audible

[703] Arming/Disarming Options

Option		OFF	ON
[5]	Restrict arming on battery failure	<input type="checkbox"/> Disabled	<input type="checkbox"/> Enabled
[6]	Restrict arming on tamper failure (Zone + Bus Module + Wireless PGM)	<input type="checkbox"/> Disabled	<input type="checkbox"/> Enabled
[7]	Restrict arming on wireless supervision trouble (Wireless zones + Wireless PGM)*	<input type="checkbox"/> Disabled	<input type="checkbox"/> Enabled

* Does not apply to SP4000 systems.

[704] Arming/Disarming Options

Option		OFF	ON
[1]	Regular arming switches to force arming	<input type="checkbox"/> Disabled	<input type="checkbox"/> Enabled
[2]	Stay arming switches to stay force arming	<input type="checkbox"/> Disabled	<input type="checkbox"/> Enabled
[3]	Sleep arming switches to sleep force arming	<input type="checkbox"/> Disabled	<input type="checkbox"/> Enabled

System Timers

Section	Data	Description
[710]	___/___/___	(000 to 255) seconds Entry delay 1 (default 045)
[711]	___/___/___	(000 to 255) seconds Entry delay 2 (default 045)
[712]	___/___/___	(000 to 015) Auto zone shutdown counter (default 005)
[713]	___/___/___	(000 to 255) seconds Intellizone delay (default 048)
[714]	___/___/___	(000 to 255) minutes Recycle alarm delay (default 000)
[715]	___/___/___	(000 to 255) Recycle alarm counter (default 000)
[718]	___/___/___	(000 to 255) seconds Remote panic disarm lock delay (default 000)
[719]	___/___/___	(000 to 255) days Closing delinquency delay (default 000)
[720]	___/___/___	(000 to 255) seconds Flex-Instant delay (default 015)
[721]	___/___/___	(000 to 255) seconds For StayD: Re-arm delay (default 005)

Daylight Savings Programming

[730]

Option

[1] Daylight savings (does not apply to SP4000 systems)

OFF

Disabled

ON

Enabled

Section

[731] ___/___

Data

00 to 99

Description

Country code

Country Code List

00 = Mexico, St.Johns, Bahamas, Turks and Caicos
 01 = Cuba
 02 = Brazil
 03 = Chile
 04 = Falklands
 05 = Paraguay
 06 = European Union, UK, and Greenland
 07 = Russia and most states of the former USSR
 08 = Australia- South Australia, Victoria, Australian Capital Territory, New South Wales

09 = Lord Howe Island- Tasmania
 10 = Chatham
 11 = Tonga
 12 = Iraq and Syria
 13 = Israel
 14 = Lebanon, Kirgizstan
 15 = Palestine
 16 = Egypt
 17 = Namibia
 18 = USA, Canada
 19 = New Zealand

Customized Daylight Saving Programming

In addition to using the default Daylight Saving Time (DST) settings in section [731], you can also set a customized DST. Set section [732] for the DST starting period and [733] for the DST ending period. Both sections recognize 5 different entries of 2 digits each. All entries must be assigned in this respective order:

Months	01 to 12	01 = January	*If the Day value is set to (00), the Day is ignored and the DST change will respect only the Date value.
Date	01 to 31	01 = First day of the month	
Day**	00 to 07	00 = Default*, 01 = Sunday	
Hours	00 to 23	00 = Midnight	** If the Day setting is set to a value other than 00 (e.g. 03 - Tuesday), the DST time change will occur on the first 'Tuesday' following the programmed Date value.
Minutes	00 only	00 = 60 minutes or 1 hour	

If you have modified sections [732] and [733] but want to revert to a standard DST code, change all of the settings in [732] and [733] to (00).

Daylight Savings Start/End Period

Section

[732] ___/___/___/___/___/___/___/___/___/___/___/___

Data

Month-date-day-hours-minutes

Description

Daylight Savings Time Starting Period

[733] ___/___/___/___/___/___/___/___/___/___/___/___

Month-date-day-hours-minutes

Daylight Savings Time Ending Period

[803] Event Call Direction Options 2

Option		OFF	ON
[1]	Call tel. #1 / monitoring rcvr. #1 for tamper/restore report codes	<input type="checkbox"/> Disabled	<input checked="" type="checkbox"/> Enabled
[2]	Call tel. #2 / monitoring rcvr. #2 for tamper/restore report codes	<input type="checkbox"/> Disabled	<input checked="" type="checkbox"/> Enabled
[3]	Call pager for tamper/restore report codes	<input checked="" type="checkbox"/> Disabled	<input type="checkbox"/> Enabled
[5]	Call tel. #1 / monitoring rcvr. #1 for trouble/restore report codes	<input type="checkbox"/> Disabled	<input checked="" type="checkbox"/> Enabled
[6]	Call tel. #2 / monitoring rcvr. #2 for trouble/restore report codes	<input type="checkbox"/> Disabled	<input checked="" type="checkbox"/> Enabled
[7]	Call pager for trouble/restore report codes	<input checked="" type="checkbox"/> Disabled	<input type="checkbox"/> Enabled

[804] Event Call Direction Options 3

Option		OFF	ON
[1]	Call tel. #1 / monitoring rcvr. #1 for special report codes	<input type="checkbox"/> Disabled	<input checked="" type="checkbox"/> Enabled
[2]	Call tel. #2 / monitoring rcvr. #2 for special report codes	<input type="checkbox"/> Disabled	<input checked="" type="checkbox"/> Enabled
[3]	Call pager for special report codes	<input checked="" type="checkbox"/> Disabled	<input type="checkbox"/> Enabled
[5]	Call personal tel. # on zone alarm (burglary/fire)	<input type="checkbox"/> Disabled	<input checked="" type="checkbox"/> Enabled
[6]	Call personal tel. # on panic alarms	<input type="checkbox"/> Disabled	<input checked="" type="checkbox"/> Enabled
[7]	Call personal tel. # on paramedic alarm	<input type="checkbox"/> Disabled	<input checked="" type="checkbox"/> Enabled
[8]	Call personal tel. # on panel power trouble	<input checked="" type="checkbox"/> Disabled	<input type="checkbox"/> Enabled

Communication Settings

Section	Data	Description
[810]	___/___ TEL1 TEL2	Reporting format 0 = Ademco Slow 1 = Silent Knight Fast 2 = Sescoa 3 = Ademco Express 4 = Ademco Contact ID (default) 5 = SIA (not supported with GPRS/IP reporting)
[811]	___/___/___/___	Partition 1 Account number (landline / GSM communication only)
[812]	___/___/___/___	Partition 2 Account number (landline / GSM communication only)

General Timers

Section	Data	Description
[833]	___/___/___	(000 to 255) seconds Delay alarm transmission (default 000)
[838]	___/___/___	(000 to 255) seconds Recent closing delay (default 000)
[839]	___/___/___	(000 to 255) minutes Power failure report delay (default 015)
[840]	___/___/___	(000 to 255) days Auto test report (default 000) (see section [801] options [3] and [4] on page 22)
[850]	___/___/___/___	HH: MM Auto test report time of day (default 00:00) (see section [801] options [3] and [4] on page 22)
[851]	___/___/___	(000 to 255) minutes Armed report delay (default 005)
[852]	___/___/___	(000 to 255) minutes Disarmed report delay (default 060)

Communication Timers

Section	Data	Description
[820]	___/___/___	(000 to 255) hours Fail to Comm. Clear Event Timer (default 000 = disabled)
[830]	___/___/___	(000 to 255) x 2 seconds TLM fail delay (default 016) (landline only)
[831]	___/___/___	(000 to 032) Maximum dialing attempts monitoring station (default 008) (landline only)
[832]*	___/___/___	(000 to 127) seconds Delay between dialing attempts* (default 020) (landline / GSM only)
[834]	___/___/___	(000 to 127) seconds Pager reporting delay (default 020)
[835]	___/___/___	(000 to 010) Pager reporting message repetition (default 003)
[836]*	___/___/___	(000 to 127) seconds Personal reporting delay* (default 005)
[837]*	___/___/___	(000 to 010) Personal reporting message repetition* (default 003)
[901]*	___/___/___	(000 to 255) rings Number of rings* (default 008)
[902]*	___/___/___	(000 to 255) sec. (max 127) Answering machine override delay* (default 030)

* This section also applies when using a VDMP3 Plug-In Voice Dialer.

VDMP3 Options

[703] Arm/disarm with VDMP3

Option

[8] Arm/disarm with VDMP3

OFF

Disabled

ON

Enabled

Section

[841] ____/____/____

Data

(000 to 032)

Description

Maximum voice dialing attempts - VDMP3 (default 008)

NOTE: For more VDMP3 options, see *Communication Timers* on page 23.

Landline Communication

Panels can be programmed for landline reporting using the following sections:

[800] Dialer Options

Option

[1] & [2]

Telephone Line Monitoring (TLM) Options		
[1]	[2]	
off	off	Disabled
off	on	Trouble only
on	off	When disarmed: Trouble only When armed: Audible alarm
on	on	Silent alarms become Audible alarm

OFF

See Table

ON

See Table

[3] Switch to pulse on 5th attempt

Disabled

Enabled

[4] Alternate dial

Disabled

Enabled

[5] Force dial (must be enabled to comply with TBR-21)

Disabled

Enabled

[6] DTMF dialing

Disabled

Enabled

[7] Pulse ratio

1:2

1:1.5

[8] Reporting*

Dialer activated

No dialer

* This option also applies to GSM communication.

Communication Settings

Section Data

[815]* _____
MONITORING STATION TELEPHONE NUMBER 1

[816]* _____
MONITORING STATION TELEPHONE NUMBER 2

[817]* _____
BACKUP TELEPHONE NUMBER

[818]* _____
PAGER TELEPHONE NUMBER

[819]* _____
NUMERIC MESSAGE SENT WITH PAGER REPORTING

* This option also applies to GSM communication.



Refer to the *Installer Quick Menu* on page 65 and the *Master Quick Menu* in the User Guide for programming telephone numbers.

NOTE: To erase a phone number/numeric message, press the **[SLEEP]** key for each digit in the respective section.

Special Keys for Telephone Numbers	
Press	Action or Value
[OFF]	*
[BYP]	#
[MEM]	switch from pulse to tone dialing or vice versa
[TBL]	4-second pause
[SLEEP]	deletes current digit
[]	inserts blank space

GSM Communication

Systems that include the PCS Series (GSM) can be programmed for GSM communication using the following sections:

[800] Reporting

Option **OFF** Dialer activated **ON** Dialer deactivated

[8] Reporting*

* This option also applies to landline communication.

Section Data

[815]* _____
MONITORING STATION TELEPHONE NUMBER 1

[816]* _____
MONITORING STATION TELEPHONE NUMBER 2

[817]* _____
BACKUP TELEPHONE NUMBER

[818]* _____
PAGER TELEPHONE NUMBER

[819]* _____
NUMERIC MESSAGE SENT WITH PAGER REPORTING

* This option also applies to landline communication.

NOTE: To erase a phone number/numeric message, press the **[SLEEP]** key for each digit in the respective section.

Special Keys for Telephone Numbers	
Press	Action or Value
[OFF]	*
[BYP]	#
[MEM]	switch from pulse to tone dialing or vice versa
[TBL]	4-second pause
[SLEEP]	deletes current digit
[]	inserts blank space

PCS Series Programming

[805] GSM Options

Option

		GSM Reporting	
[1]	[2]	Primary	Backup
OFF	OFF	Landline	Landline
OFF	ON	Landline	GSM
ON	OFF	GSM	Landline
ON	ON	GSM	GSM

[3] & [4] Future use

		GSM No Service Trouble Feedback
[5]	[6]	
OFF	OFF	Disabled
OFF	ON	Trouble only
ON	OFF	When disarmed: Trouble only When armed: Audible alarm
ON	ON	Silent alarm becomes audible alarm

[7] Future use

[8] GSM RF jamming supervision **OFF** Disabled **ON** Enabled

PCS Series (GSM) Settings

Section	Data	Description
[855] ___/___/___	(000 to 255) x 2 seconds	GSM no service timer (default 016)
[856] ___/___/___	(000 to 255)	SMS language (default 000)

Table 6: SMS Language ID

Language	ID	Language	ID	Language	ID	Language	ID
English	000	Portuguese	006	Croatian	012	Slovak	018
French	001	German	007	Greek	013	Chinese	019
Spanish	002	Turkish	008	Hebrew	014	Serbian	020
Italian	003	Hungarian	009	Russian	015	Future use	021 to 255
Swedish	004	Czech	010	Bulgarian	016		
Polish	005	Dutch	011	Romanian	017		

Communication Report Codes

[966] Clear Communication Report Codes

Option	OFF	ON
[6] Clear report code for GSM lost communication with panel*	<input type="checkbox"/> Disabled	<input checked="" type="checkbox"/> Enabled

* Ensure all other options are deselected. Press [ENTER] to clear the respective set of report codes before exiting the section.

[967] Reset Communication Report Codes

Option	OFF	ON
[6] Reset report code for GSM lost communication with panel*	<input type="checkbox"/> Disabled	<input checked="" type="checkbox"/> Enabled

* Ensure all other options are deselected. Press [ENTER] to reset the respective set of report codes before exiting the section.

Communication Report Codes

[879]* ___/___	PCS Series RF jam	[884]* ___/___	GSM lost communication with panel
___/___	PCS Series no service	___/___	N/A
___/___	PCS Series module supervision lost	___/___	N/A
___/___	Receiver fail to communicate (GPRS)	___/___	N/A

Communication Restore Report Codes

[881]* ___/___	PCS Series RF jam
___/___	PCS Series no service
___/___	PCS Series module supervision lost
___/___	Receiver fail to communicate (GPRS)

* This section also applies to network communication programming.

Network Communication (GPRS/GSM)

Systems that report using the PCS Series (GPRS) or the IP100 can be programmed for TCP/IP communication using the following sections:

IP100 / PCS Series (GPRS) Options

[806] IP/GPRS Options

Option

[5] & [6]

IP/GPRS No Service Trouble Feedback		
[5]	[6]	
OFF	OFF	Disabled
OFF	ON	Trouble only
ON	OFF	When disarmed: Trouble only When armed: Audible alarm
ON	ON	Silent alarm becomes audible alarm

[7] Use dialer reporting	<input type="checkbox"/> Disabled	<input checked="" type="checkbox"/> As IP/GPRS reporting backup	<input type="checkbox"/> In addition to IP/GPRS reporting
[8] Enable IP/GPRS reporting	<input type="checkbox"/> Disabled		<input checked="" type="checkbox"/> Enabled

IP Account Numbers

[918] ___/___/___/___
IP ACCOUNT PARTITION 1 (e.g. 1234)

[919] ___/___/___/___
IP ACCOUNT PARTITION 2 (e.g. 1234)

Table 7: IP/GPRS Registration Status

Main Menu Trouble	Sub-Menu Trouble Menu
[1] IP/GPRS module registration status	[1] OFF = Unregistered [1] Slow Flash = Registering... [1] ON = Registration OK
[2] IP/GPRS module error	[7] No IP/GPRS module [8] Ethernet cable unplugged/GSM no service [9] No IP address acquired by module/GPRS network trouble
[3] IP/GPRS programming error	[7] No IP address (not programmed) [8] No IP port (not programmed) [9] No IP account (not programmed) [10] No Access point name (not programmed - GPRS only)
[4] IP/GPRS registration error	[7] Cannot connect [8] Invalid profile [9] Invalid format [10] Account already registered under another MAC address
Register module	When all troubles are cleared, press [ARM] to register module.

WinLoad / BabyWare / PCS Series Connection Settings

- [780] _____
SMS SITE NAME
- [920] _____
PORT (DEFAULT = 10000)
- [921] _____
ACCESS POINT NAME (APN) PART 1 (E.G. INTERNET.COM)
- [922] _____
ACCESS POINT NAME (APN) PART 2
- [923] _____
USER NAME PART 1
- [924] _____
USER NAME PART 2
- [925] _____
PASSWORD PART 1
- [926] _____
PASSWORD PART 2
- [927] _____
INSTALLER SOFTWARE PASSWORD (WINLOAD / BABYWARE) (DEFAULT = ADMIN)

 Refer to the *Installer Quick Menu* on page 65 for alternate programming of PC phone number, panel ID, and PC password.

Communication Report Codes

- | | | | | | |
|--------|-----------|-------------------------------------|-------|-----------|---------------------------------|
| [879]* | ____/____ | PCS Series RF jam | [880] | ____/____ | N/A |
| | ____/____ | PCS Series no service | | ____/____ | IP100 no service |
| | ____/____ | PCS Series module supervision lost | | ____/____ | IP100 supervision lost |
| | ____/____ | Receiver fail to communicate (GPRS) | | ____/____ | IP receiver fail to communicate |

Communication Restore Report Codes

- | | | | | | |
|--------|-----------|-------------------------------------|-------|-----------|---------------------------------|
| [881]* | ____/____ | PCS Series RF jam | [882] | ____/____ | N/A |
| | ____/____ | PCS Series no service | | ____/____ | IP100 no service |
| | ____/____ | PCS Series module supervision lost | | ____/____ | IP100 supervision lost |
| | ____/____ | Receiver fail to communicate (GPRS) | | ____/____ | IP receiver fail to communicate |

* This section also applies to GSM communication programming.

Section		Event Group #	Sub-Group #	Partition # (99 for both partitions)	Default
[236]	PGM 9: Activation Event	(___/___)	(___/___)	(___/___)	00/00/00
[237]	Deactivation Event	(___/___)	(___/___)	(___/___)	00/00/00
[238]	PGM 10: Activation Event	(___/___)	(___/___)	(___/___)	00/00/00
[239]	Deactivation Event	(___/___)	(___/___)	(___/___)	00/00/00
[240]	PGM 11: Activation Event	(___/___)	(___/___)	(___/___)	00/00/00
[241]	Deactivation Event	(___/___)	(___/___)	(___/___)	00/00/00
[242]	PGM 12: Activation Event	(___/___)	(___/___)	(___/___)	00/00/00
[243]	Deactivation Event	(___/___)	(___/___)	(___/___)	00/00/00
[244]	PGM 13: Activation Event	(___/___)	(___/___)	(___/___)	00/00/00
[245]	Deactivation Event	(___/___)	(___/___)	(___/___)	00/00/00
[246]	PGM 14: Activation Event	(___/___)	(___/___)	(___/___)	00/00/00
[247]	Deactivation Event	(___/___)	(___/___)	(___/___)	00/00/00
[248]	PGM 15: Activation Event	(___/___)	(___/___)	(___/___)	00/00/00
[249]	Deactivation Event	(___/___)	(___/___)	(___/___)	00/00/00
[250]	PGM 16: Activation Event	(___/___)	(___/___)	(___/___)	00/00/00
[251]	Deactivation Event	(___/___)	(___/___)	(___/___)	00/00/00

* Section [220] PGM 1 Activation Event **default** = (Option B Remote Assignment) Button pressed on Any remote/Any partition.

† Section [222] PGM 2 Activation Event **default** = (Option C Remote Assignment) Button pressed on Any remote/Any partition.

NOTE: See Button Options Table on page 52.

Event Description

Event Group #	Sub-group #
00 = Zone OK	01 to 32 = Zone number
01 = Zone open	99 = Any zone number
02 = Partition status	00 to 01= N/A 02 = Silent alarm 03 = Buzzer alarm 04 = Steady alarm 05 = Pulsed alarm 06 = Strobe 07 = Alarm stopped 08 = Squawk ON (Partition 1 only) 09 = Squawk OFF (Partition 1 only) 10 = Ground start (Partition 1 only) 11 = Disarm partition 12 = Arm partition 13 = Entry delay started 14 = Exit delay started 15 = Pre-alarm delay 16 = Report confirmation 99 = Any partition status event
03 = Bell status (Partition 1 only)	00 = Bell OFF 01 = Bell ON 02 = Bell squawk arm 03 = Bell squawk disarm 99 = Any bell status event

Event Group #	Sub-group #
06 = Non-reportable event	00 = Telephone line trouble 01 = [ENTER] / [CLEAR] / [⏏] key was pressed (Partition 1 only) 02 = N/A 03 = Arm in stay mode 04 = Arm in sleep mode 05 = Arm in force mode 06 = Full arm when armed in stay mode 07 = PC fail to communicate (Partition 1 only) 08 = Utility Key 1 pressed (keys [1] and [2]) (Partition 1 only) 09 = Utility Key 2 pressed (keys [4] and [5]) (Partition 1 only) 10 = Utility Key 3 pressed (keys [7] and [8]) (Partition 1 only) 11 = Utility Key 4 pressed (keys [2] and [3]) (Partition 1 only) 12 = Utility Key 5 pressed (keys [5] and [6]) (Partition 1 only) 13 = Utility Key 6 pressed (keys [8] and [9]) (Partition 1 only) 14 = Tamper generated alarm 15 = Supervision loss generated alarm 16 = N/A 17 = N/A 18 = N/A 19 = N/A 20 = Full arm when armed in sleep mode 21 = Firmware upgrade -Partition 1 only (non-PGM event) 22 = N/A 23 = StayD mode activated 24 = StayD mode deactivated 25 = IP Registration status change 26 = GPRS Registration status change 99 = Any non-reportable event
08 = Button pressed on remote (See button option "B" on page 52) 09 = Button pressed on remote (See button option "C" on page 52) 10 = Button pressed on remote (See button option "D" on page 52) 11 = Button pressed on remote (See button option "E" on page 52)	01 to 32 = Remote control number 99 = Any remote control number
12 = Cold start wireless zone	01 to 32 = Zone number 99 = Any zone number
13 = Cold start wireless module (Partition 1 only)	01 to 16 = Output number 17 to 18 = Wireless repeater 19 to 22 = Wireless keypad 99 = Any output number
14 = Bypass programming 15 = User code activated output (Partition 1 only)	01 to 32 = User number 99 = Any user number
16 = Wireless smoke maintenance signal 17 = Delay zone alarm transmission 18 = Zone signal strength weak 1 (Partition 1 only) 19 = Zone signal strength weak 2 (Partition 1 only) 20 = Zone signal strength weak 3 (Partition 1 only) 21 = Zone signal strength weak 4 (Partition 1 only)	01 to 32 = Zone number 99 = Any zone number
22 = Button pressed on remote (see button option "5") 23 = Button pressed on remote (see button option "6")	01 to 32 = Remote control number 99 = Any remote control number
24 = Fire Delay started	01 to 32 = Zone number 99 = Any zone number
25 = N/A	

Event Group #	Sub-group #
26 = Software Access (VDMP3, IP100, WinLoad, BabyWare)	00 = Non-valid source ID 01 = WinLoad / BabyWare direct 02 = WinLoad / BabyWare through IP module 03 = WinLoad / BabyWare through GSM module 04 = WinLoad / BabyWare through modem 09 = IP100 direct 10 = VDMP3 direct 11 = Voice through GSM module 12 = Remote access 13 = SMS through GSM module 99 = Any software access
27 = Bus module event	00 = A bus module was added 01 = A bus module was removed 02 = 2-way RF Module Communication Failure 03 = 2-way RF Module Communication Restored
28 = StayD pass acknowledged	01 to 32 = Zone number 99 = Any zone number
29 = Arming with user	01 to 32 = User number 99 = Any user number
30 = Special arming	00 = Auto-arming (on time/no movement) 01 = Late to close 02 = No movement arming 03 = Partial arming 04 = Quick arming 05 = Arming through WinLoad / BabyWare 06 = Arming with keyswitch 99 = Any special arming
31 = Disarming with user 32 = Disarming after alarm with user 33 = Alarm cancelled with user	01 to 32 = User number 99 = Any user number
34 = Special disarming	00 = Auto-arm cancelled (on time/no movement) 01 = Disarming through WinLoad / BabyWare 02 = Disarming through WinLoad / BabyWare after alarm 03 = Alarm cancelled through WinLoad / BabyWare 04 = Paramedical alarm cancelled 05 = Disarm with keyswitch 06 = Disarm with keyswitch after an alarm 07 = Alarm cancelled with keyswitch 99 = Any special disarming
35 = Zone bypassed 36 = Zone in alarm 37 = Fire alarm 38 = Zone alarm restore 39 = Fire alarm restore	01 to 32 = Zone number 99 = Any zone number
40 = Special alarm	00 = Panic non-medical emergency 01 = Panic medical (this panic alarm is not UL approved) 02 = Panic fire 03 = Recent closing 04 = Global shutdown 05 = Duress alarm 06 = Keypad lockout (Partition 1 only) 99 = Any special alarm event
41 = Zone shutdown 42 = Zone tampered 43 = Zone tamper restore	01 to 32 = Zone number 99 = Any zone number

Event Group #	Sub-group #
44 = New trouble (Partition 1 only except sub-group 07 = both partitions)	00 = N/A 01 = AC failure 02 = Battery failure 03 = Auxiliary current overload 04 = Bell current overload 05 = Bell disconnected 06 = Clock loss 07 = Fire loop trouble 08 = Fail to communicate to monitoring station telephone #1 09 = Fail to communicate to monitoring station telephone #2 11 = Fail to communicate to voice report 12 = RF jamming 13 = GSM RF jamming 14 = GSM no service 15 = GSM supervision lost 16 = Fail To Communicate IP Receiver 1 (GPRS) 17 = Fail To Communicate IP Receiver 2 (GPRS) 18 = IP Module No Service 19 = IP Module Supervision Loss 20 = Fail To Communicate IP Receiver 1 (IP) 21 = Fail To Communicate IP Receiver 2 (IP) 99 = Any new trouble event
45 = Trouble restored	00 = Telephone line restored 01 = AC failure restore 02 = Battery failure restore 03 = Auxiliary current overload restore 04 = Bell current overload restore 05 = Bell disconnected restore 06 = Clock loss restore 07 = Fire loop trouble restore 08 = Fail to communicate to monitoring station telephone #1 restore 09 = Fail to communicate to monitoring station telephone #2 restore 11 = Fail to communicate to voice report restore 12 = RF jamming restore 13 = GSM RF jamming restore 14 = GSM no service restore 15 = GSM supervision lost restore 16 = Fail To Communicate restore IP Receiver 1 (GPRS) 17 = Fail To Communicate restore IP Receiver 2 (GPRS) 18 = IP Module No Service restore 19 = IP Module Supervision loss restore 20 = Fail To Communicate restore IP Receiver 1 (IP) 21 = Fail To Communicate restore IP Receiver 2 (IP) 99 = Any trouble restored event
46 = Bus / EBus / Wireless module new trouble (Partition 1 only)	00 = Bus / EBus / Wireless module communication fault 01 = Tamper trouble 02 = Power fail 03 = Battery failure 99 = Any bus module new trouble event
47 = Bus / EBus / Wireless module trouble restored (Partition 1 only)	00 = Bus / EBus / Wireless module communication fault restore 01 = Tamper trouble restore 02 = Power fail 03 = Battery failure 99 = Any bus module trouble restored event

Event Group #	Sub-group #
48 = Special (Partition 1 only)	00 = System power up 01 = Reporting test 02 = Software log on 03 = Software log off 04 = Installer in programming mode 05 = Installer exited programming mode 06 = Maintenance in programming mode 07 = Maintenance exited programming mode 08 = Closing delinquency delay elapsed 99 = Any special event
49 = Low battery on zone 50 = Low battery on zone restore 51 = Zone supervision trouble 52 = Zone supervision restore	01 to 32 = Zone number 99 = Any zone number
53 = Wireless module supervision trouble (Partition 1 only) 54 = Wireless module supervision restore (Partition 1 only) 55 = Wireless module tamper trouble (Partition 1 only) 56 = Wireless module tamper restore (Partition 1 only)	01 to 16 = Output 17 to 18 = Wireless repeater 19 to 22 = Wireless keypad 27 to 30 = Wireless siren
57 = Non-medical alarm (paramedic)	01 to 32 = User number 99 = Any user number
58 = Zone forced 59 = Zone included	01 to 32 = Zone number 99 = Any zone number
64 = System Status*	00 = Follow Arm LED status**: 1. PGM pulse fast in alarm 2. PGM pulse fast in exit delay below 10 sec. 3. PGM pulse slow in exit delay over 10 sec. 4. PGM steady ON if armed 5. PGM OFF if disarmed *On-board PGMs only ** This event can be assigned to any partition. If assigned to both partitions, the PGM event will follow the priority of the list above, with #1 being the highest priority.



Refer to the *Installer Quick Menu* on page 65 for alternate PGM programming.

Programmable Output Options

Option	PGM 1 [261]		PGM 2 [262]		PGM 3 [263]		PGM 4 [264]	
	OFF	ON	OFF	ON	OFF	ON	OFF	ON
[1] PGM Base Time (Off=Sec, On=Min)	<input type="checkbox"/>	<input type="checkbox"/>	<input type="checkbox"/>	<input type="checkbox"/>	<input type="checkbox"/>	<input type="checkbox"/>	<input type="checkbox"/>	<input type="checkbox"/>
[2] PGM State (Off=N.O., On=N.C.)	<input type="checkbox"/>	<input type="checkbox"/>	<input type="checkbox"/>	<input type="checkbox"/>	<input type="checkbox"/>	<input type="checkbox"/>	<input type="checkbox"/>	<input type="checkbox"/>
[3]* PGM Supervision	<input type="checkbox"/>	<input checked="" type="checkbox"/>	<input type="checkbox"/>	<input checked="" type="checkbox"/>	<input type="checkbox"/>	<input checked="" type="checkbox"/>	<input type="checkbox"/>	<input checked="" type="checkbox"/>
[4] PGM Activation Mode (Off=Steady, On=Pulse)	<input type="checkbox"/>	<input type="checkbox"/>	<input checked="" type="checkbox"/>	<input type="checkbox"/>	<input checked="" type="checkbox"/>	<input type="checkbox"/>	<input checked="" type="checkbox"/>	<input type="checkbox"/>
[5] PGM Pulse once every 30 seconds if armed	<input type="checkbox"/>	<input type="checkbox"/>	<input type="checkbox"/>	<input type="checkbox"/>	<input type="checkbox"/>	<input type="checkbox"/>	<input type="checkbox"/>	<input type="checkbox"/>
[6] PGM Pulse on any alarm	<input type="checkbox"/>	<input type="checkbox"/>	<input type="checkbox"/>	<input type="checkbox"/>	<input type="checkbox"/>	<input type="checkbox"/>	<input type="checkbox"/>	<input type="checkbox"/>
[7] PGM Pulse on any alarm (OFF= Partition 1, On= Partition 2)	<input type="checkbox"/>	<input type="checkbox"/>	<input type="checkbox"/>	<input type="checkbox"/>	<input type="checkbox"/>	<input type="checkbox"/>	<input type="checkbox"/>	<input type="checkbox"/>
[8] N/A	N/A	N/A	N/A	N/A	N/A	N/A	N/A	N/A

Option	PGM 5 [265]		PGM 6 [266]		PGM 7 [267]		PGM 8 [268]	
	OFF	ON	OFF	ON	OFF	ON	OFF	ON
[1] PGM Base Time (Off=Sec., On=Min.)	<input type="checkbox"/>	<input type="checkbox"/>	<input type="checkbox"/>	<input type="checkbox"/>	<input type="checkbox"/>	<input type="checkbox"/>	<input type="checkbox"/>	<input type="checkbox"/>
[2] PGM State (Off=N.O., On= N.C.)	<input type="checkbox"/>	<input type="checkbox"/>	<input type="checkbox"/>	<input type="checkbox"/>	<input type="checkbox"/>	<input type="checkbox"/>	<input type="checkbox"/>	<input type="checkbox"/>
[3]* PGM Supervision	<input type="checkbox"/>	<input checked="" type="checkbox"/>	<input type="checkbox"/>	<input checked="" type="checkbox"/>	<input type="checkbox"/>	<input checked="" type="checkbox"/>	<input type="checkbox"/>	<input checked="" type="checkbox"/>
[4] PGM Activation Mode (Off=Steady, On=Pulse)	<input type="checkbox"/>	<input type="checkbox"/>	<input type="checkbox"/>	<input type="checkbox"/>	<input type="checkbox"/>	<input type="checkbox"/>	<input type="checkbox"/>	<input type="checkbox"/>
[5] PGM Pulse once every 30 seconds if armed	<input type="checkbox"/>	<input type="checkbox"/>	<input type="checkbox"/>	<input type="checkbox"/>	<input type="checkbox"/>	<input type="checkbox"/>	<input type="checkbox"/>	<input type="checkbox"/>
[6] PGM Pulse on any alarm	<input type="checkbox"/>	<input type="checkbox"/>	<input type="checkbox"/>	<input type="checkbox"/>	<input type="checkbox"/>	<input type="checkbox"/>	<input type="checkbox"/>	<input type="checkbox"/>
[7] PGM Pulse on any alarm (OFF= Partition 1, On= Partition 2)	<input type="checkbox"/>	<input type="checkbox"/>	<input type="checkbox"/>	<input type="checkbox"/>	<input type="checkbox"/>	<input type="checkbox"/>	<input type="checkbox"/>	<input type="checkbox"/>
[8] N/A	N/A	N/A	N/A	N/A	N/A	N/A	N/A	N/A

Option	PGM 9 [269]		PGM 10 [270]		PGM 11 [271]		PGM 12 [272]	
	OFF	ON	OFF	ON	OFF	ON	OFF	ON
[1] PGM Base Time (Off=Sec, On=Min)	<input type="checkbox"/>	<input type="checkbox"/>	<input type="checkbox"/>	<input type="checkbox"/>	<input type="checkbox"/>	<input type="checkbox"/>	<input type="checkbox"/>	<input type="checkbox"/>
[2] PGM State (Off=N.O., On=N.C.)	<input type="checkbox"/>	<input type="checkbox"/>	<input type="checkbox"/>	<input type="checkbox"/>	<input type="checkbox"/>	<input type="checkbox"/>	<input type="checkbox"/>	<input type="checkbox"/>
[3]* PGM Supervision	<input type="checkbox"/>	<input checked="" type="checkbox"/>	<input type="checkbox"/>	<input checked="" type="checkbox"/>	<input type="checkbox"/>	<input checked="" type="checkbox"/>	<input type="checkbox"/>	<input checked="" type="checkbox"/>
[4] PGM Activation Mode (Off=Steady, On=Pulse)	<input type="checkbox"/>	<input type="checkbox"/>	<input type="checkbox"/>	<input type="checkbox"/>	<input type="checkbox"/>	<input type="checkbox"/>	<input type="checkbox"/>	<input type="checkbox"/>
[5] PGM Pulse once every 30 seconds if armed	<input type="checkbox"/>	<input type="checkbox"/>	<input type="checkbox"/>	<input type="checkbox"/>	<input type="checkbox"/>	<input type="checkbox"/>	<input type="checkbox"/>	<input type="checkbox"/>
[6] PGM Pulse on any alarm	<input type="checkbox"/>	<input type="checkbox"/>	<input type="checkbox"/>	<input type="checkbox"/>	<input type="checkbox"/>	<input type="checkbox"/>	<input type="checkbox"/>	<input type="checkbox"/>
[7] PGM Pulse on any alarm (OFF= Partition 1, On= Partition 2)	<input type="checkbox"/>	<input type="checkbox"/>	<input type="checkbox"/>	<input type="checkbox"/>	<input type="checkbox"/>	<input type="checkbox"/>	<input type="checkbox"/>	<input type="checkbox"/>
[8] N/A	N/A	N/A	N/A	N/A	N/A	N/A	N/A	N/A

Option	PGM 13 [273]		PGM 14 [274]		PGM 15 [275]		PGM 16 [276]	
	OFF	ON	OFF	ON	OFF	ON	OFF	ON
[1] PGM Base Time (Off=Sec, On=Min)	<input type="checkbox"/>	<input type="checkbox"/>	<input type="checkbox"/>	<input type="checkbox"/>	<input type="checkbox"/>	<input type="checkbox"/>	<input type="checkbox"/>	<input type="checkbox"/>
[2] PGM State (Off=N.O., On=N.C.)	<input type="checkbox"/>	<input type="checkbox"/>	<input type="checkbox"/>	<input type="checkbox"/>	<input type="checkbox"/>	<input type="checkbox"/>	<input type="checkbox"/>	<input type="checkbox"/>
[3]* PGM Supervision	<input type="checkbox"/>	<input checked="" type="checkbox"/>	<input type="checkbox"/>	<input checked="" type="checkbox"/>	<input type="checkbox"/>	<input checked="" type="checkbox"/>	<input type="checkbox"/>	<input checked="" type="checkbox"/>
[4] PGM Activation Mode (Off=Steady, On=Pulse)	<input type="checkbox"/>	<input type="checkbox"/>	<input type="checkbox"/>	<input type="checkbox"/>	<input type="checkbox"/>	<input type="checkbox"/>	<input type="checkbox"/>	<input type="checkbox"/>
[5] PGM Pulse once every 30 seconds if armed	<input type="checkbox"/>	<input type="checkbox"/>	<input type="checkbox"/>	<input type="checkbox"/>	<input type="checkbox"/>	<input type="checkbox"/>	<input type="checkbox"/>	<input type="checkbox"/>
[6] PGM Pulse on any alarm	<input type="checkbox"/>	<input type="checkbox"/>	<input type="checkbox"/>	<input type="checkbox"/>	<input type="checkbox"/>	<input type="checkbox"/>	<input type="checkbox"/>	<input type="checkbox"/>
[7] PGM Pulse on any alarm (OFF= Partition 1, On= Partition 2)	<input type="checkbox"/>	<input type="checkbox"/>	<input type="checkbox"/>	<input type="checkbox"/>	<input type="checkbox"/>	<input type="checkbox"/>	<input type="checkbox"/>	<input type="checkbox"/>
[8] N/A	N/A	N/A	N/A	N/A	N/A	N/A	N/A	N/A

* This option does not apply to SP4000 systems.

Programmable Output Delays

Section	(000 to 255 x 1 sec./mins.)*	Section	(000 to 255 x 1 sec./mins.)*	(Default = 005)
[281] PGM 1:	___/___/___	[289] PGM 9:	___/___/___	
[282] PGM 2:	___/___/___	[290] PGM 10:	___/___/___	
[283] PGM 3:	___/___/___	[291] PGM 11:	___/___/___	
[284] PGM 4:	___/___/___	[292] PGM 12:	___/___/___	
[285] PGM 5:	___/___/___	[293] PGM 13:	___/___/___	
[286] PGM 6:	___/___/___	[294] PGM 14:	___/___/___	
[287] PGM 7:	___/___/___	[295] PGM 15:	___/___/___	
[288] PGM 8:	___/___/___	[296] PGM 16:	___/___/___	

* To change the base time (min. or sec.), refer to *Programmable Output Options* on page 34.

Programmable Output Serial Numbers

Section	Wireless PGM Serial Number	Section	Wireless PGM Serial Number
[301]	PGM 1: _____	[309]	PGM 9: _____
[302]	PGM 2: _____	[310]	PGM 10: _____
[303]	PGM 3: _____	[311]	PGM 11: _____
[304]	PGM 4: _____	[312]	PGM 12: _____
[305]	PGM 5: _____	[313]	PGM 13: _____
[306]	PGM 6: _____	[314]	PGM 14: _____
[307]	PGM 7: _____	[315]	PGM 15: _____
[308]	PGM 8: _____	[316]	PGM 16: _____

NOTE: To delete a wireless PGM, enter [000000] in its respective section.

NOTE: To view the serial number, refer to section [960].

NOTE: For automatic assignment, press the PGM's anti-tamper switch while in the respective section.



Refer to the *Installer Quick Menu* on page 65 for alternate PGM programming.

Wireless PGM Signal Strength

Section	Section
[321] PGM 1 Wireless PGM Signal Strength	[329] PGM 9 Wireless PGM Signal Strength
[322] PGM 2 Wireless PGM Signal Strength	[330] PGM 10 Wireless PGM Signal Strength
[323] PGM 3 Wireless PGM Signal Strength	[331] PGM 11 Wireless PGM Signal Strength
[324] PGM 4 Wireless PGM Signal Strength	[332] PGM 12 Wireless PGM Signal Strength
[325] PGM 5 Wireless PGM Signal Strength	[333] PGM 13 Wireless PGM Signal Strength
[326] PGM 6 Wireless PGM Signal Strength	[334] PGM 14 Wireless PGM Signal Strength
[327] PGM 7 Wireless PGM Signal Strength	[335] PGM 15 Wireless PGM Signal Strength
[328] PGM 8 Wireless PGM Signal Strength	[336] PGM 16 Wireless PGM Signal Strength

Signal Strength Indicator	8 to 10 / 3 beeps = Best signal	5 to 7 / 2 beeps = Average signal	1 to 4 / 1 beep = Weak signal (Relocate)
----------------------------------	---------------------------------	-----------------------------------	--

NOTE: To view the wireless PGM signal strength, press the wireless PGM's anti-tamper switch while in the respective section.

System Report Codes

Entering Report Codes

Ademco Slow, Silent Knight, SESCOA, and Ademco Express Formats:

Enter the desired 2-digit hex value (00-FF).

Ademco "Programmable" Format:

Enter the desired 2-digit hex values from the "Ademco Report Code List - Programmable" (see page 39). Also Note that entering FF will set the report code to the "Automatic Report Code List" (see page 40).

Ademco "All Codes" Format:

The control panel automatically generates report codes from the "Ademco Report Code List - All Codes" (see page 40).

Refer to *Decimal and Hexadecimal Values* on page 6.

Clear System Report Codes

[966] Clear Report Codes

Option	OFF	ON
[3] Clear arm/disarm/alarm report codes*	<input type="checkbox"/> Disabled	<input checked="" type="checkbox"/> Enabled
[4] Clear trouble report codes*	<input type="checkbox"/> Disabled	<input checked="" type="checkbox"/> Enabled
[5] Clear system special report codes*	<input type="checkbox"/> Disabled	<input checked="" type="checkbox"/> Enabled

* Ensure all other options are deselected. Press [ENTER] to clear the respective set of report codes before exiting the section.

Reset System Report Codes

[967] Reset Report Codes

Option		OFF	ON
[3]	Reset arm/disarm/alarm report codes to default*	<input type="checkbox"/> Disabled	<input checked="" type="checkbox"/> Enabled
[4]	Reset trouble report codes to default*	<input type="checkbox"/> Disabled	<input checked="" type="checkbox"/> Enabled
[5]	Reset system special report codes to default*	<input type="checkbox"/> Disabled	<input checked="" type="checkbox"/> Enabled

* Ensure all other options are deselected. Press [ENTER] to reset the respective set of report codes before exiting the section.

Special Arming Report Codes (Default = FF)

Section	Data	Description	Section	Data	Description
[860]	___/___	Auto-arming	[861]	___/___	Quick arming
	___/___	Late to close		___/___	Arming via PC
	___/___	No movement		___/___	Arming with Keyswitch
	___/___	Partial arming		___/___	N/A

Special Disarming Report Codes (Default = FF)

Section	Data	Description
[862]	___/___	Cancel auto-arm
	___/___	Disarming via PC
	___/___	Cancel alarm with user or WinLoad / BabyWare
	___/___	Cancel paramedic

Special Alarm Report Codes (Default = FF)

Section	Data	Description	Section	Data	Description
[863]	___/___	Emergency panic	[864]	___/___	Zone shutdown
	___/___	Auxiliary panic		___/___	Duress
	___/___	Fire panic		___/___	Keypad lockout
	___/___	Recent closing		___/___	Paramedic alarm

System Trouble Report Codes (Default FF)

Section	Data	Description	Section	Data	Description
[865]	___/___	N/A	[868]	___/___	Module power fail
	___/___	AC failure		___/___	Module low/no battery*
	___/___	Battery failure		___/___	Wireless zone low battery*
	___/___	Auxiliary supply		___/___	Wireless zone supervision lost*
[866]	___/___	Bell output overload	[869]	___/___	Wireless module supervision lost*
	___/___	Bell output disconnect		___/___	Wireless module tamper*
	___/___	Timer loss		___/___	N/A
	___/___	Fire loop trouble		___/___	N/A
[867]	___/___	Fail to communicate			
	___/___	RF jamming			
	___/___	Module lost			
	___/___	Module tamper			

*Does not apply to SP4000 systems

System Trouble Restore Codes (Default FF)

Section	Data	Description	Section	Data	Description
[870]	___/___	TLM	[873]	___/___	Module power fail
	___/___	AC failure		___/___	Module low/no battery*
	___/___	Battery failure		___/___	Wireless zone low battery*
	___/___	Auxiliary supply		___/___	Wireless zone supervision lost*
[871]	___/___	Bell output overload	[874]	___/___	Wireless module supervision lost*
	___/___	Bell output disconnect		___/___	Wireless module tamper*
	___/___	Timer loss		___/___	N/A
	___/___	Fire loop trouble		___/___	N/A
[872]	___/___	Fail to communicate			
	___/___	RF jamming			
	___/___	Module lost			
	___/___	Module tamper			

*Does not apply to SP4000 systems

System Special Report Codes (Default = FF)

Section	Data	Description	Section	Data	Description
[875]	___/___	Cold start	[876]	___/___	Installer in
	___/___	Test report		___/___	Installer out
	___/___	N/A		___/___	Closing Delinquency
	___/___	Software out		___/___	N/A
[878]	___/___	Disarm with Keypad			
	___/___	Disarm with Keypad after alarm			
	___/___	Alarm cancelled with Keypad			
	___/___	N/A			

NOTE: For reporting code format instructions, see page 36.

NOTE: Refer to *Decimal and Hexadecimal Values* on page 6.

Ademco Contact ID Report Codes

CID#	Reporting Code	Value	CID#	Reporting Code	Value	CID#	Reporting Code	Value
Medical Alarms - 100			321	Bell 1	48	429	Access program mode entry	91
100	Medical alarm	01	322	Bell 2	49	430	Access program mode exit	92
101	Pendant transmitter	02	323	Alarm relay	4A	431	Access threat level change	93
102	Fail to report in	03	324	Trouble relay	4B	432	Access relay/trigger fail	94
Fire Alarms - 110			325	Reversing relay	4C	433	Access RTE shunt	95
110	Fire alarm	04	326	Notification appliance chk. #3	4D	434	Access DSM shunt	96
111	Smoke	05	327	Notification appliance chk. #4	4E	Arming - 440 and 450		
112	Combustion	06	System Peripheral Troubles - 330 and 340			441	Armed Stay	97
113	Water flow	07	330	System peripheral	4F	442	Keyswitch armed Stay	98
114	Heat	08	331	Polling loop open	50	450	Exception open/close	99
115	Pull station	09	332	Polling loop short	51	451	Early open/close	9A
116	Duct	0A	333	Expansion module failure	52	452	Late open/close	9B
117	Flame	0B	334	Repeater failure	53	453	Failed to open	9C
118	Near alarm	0C	335	Local printer paper out	54	454	Failed to close	9D
Panic Alarms - 120			336	Local printer failure	55	455	Auto-arm failed	9E
120	Panic Alarm	0D	337	Exp. module DC loss	56	456	Partial arm	9F
121	Duress	0E	338	Exp. module low battery	57	457	Exit error (user)	A0
122	Silent	0F	339	Exp. module reset	58	458	User on premises	A1
123	Audible	10	341	Exp. module tamper	59	459	Recent close	A2
124	Duress - Access grated	11	342	Exp. module AC loss	5A	System - 460		
125	Duress - Egress granted	12	343	Exp. module self-test fail	5B	461	Wrong code entry	A3
Burglar Alarms - 130			344	RF receiver jam detect	5C	462	Legal code entry	A4
130	Burglary	13	Communication Troubles - 350 and 360			463	Re-arm after alarm	A5
131	Perimeter	14	350	Communication	5D	464	Auto-arm time extended	A6
132	Interior	15	351	Telco 1 fault	5E	465	Panic alarm reset	A7
133	24-hour	16	352	Telco 2 fault	5F	466	Service ON/OFF premises	A8
134	Entry/Exit	17	353	Long range radio	60	Sounder Relay Disabled - 520		
135	Day/Night	18	354	Fail to communicate	61	520	Sounder/Relay disabled	A9
136	Outdoor	19	355	Loss of radio supervision	62	521	Bell 1 disabled	AA
137	Tamper	1A	356	Loss of central polling	63	522	Bell 2 disabled	AB
138	Near alarm	1B	357	Long range radio VSWR prob.	64	523	Alarm relay disabled	AC
139	Intrusion verified	1C	Protection Loop Troubles - 370			524	Trouble relay disabled	AD
General Alarms - 140			370	Protection loop	65	525	Reversing relay disabled	AE
140	General alarm	1D	371	Protection loop open	66	526	Notification appliance chk.#3 disabled	AF
141	Polling loop open	1E	372	Protection loop short	67	527	Notification appliance chk.#4 disabled	B0
142	Polling loop short	1F	373	Fire trouble	68	Modules - 530		
143	Expansion module failure	20	374	Exit error alarm	69	531	Module added	B1
144	Sensor tamper	21	375	Panic zone trouble	6A	532	Module removed	B2
145	Expansion module tamper	22	376	Hold-up zone trouble	6B	Communication Disables - 550 and 560		
146	Silent burglary	23	377	Swinger trouble	6C	551	Dialer disabled	B3
147	Sensor supervision failure	24	378	Cross-zone trouble	6D	552	Radio transmitter disabled	B4
24-hour Non-burglary - 150 and 160			Sensor Troubles - 380 and 390			Bypasses - 570		
150	24-hour non-burglary	25	380	Sensor trouble	6E	570	Zone bypass	B5
151	Gas detected	26	381	Loss of supervision - RF	6F	571	Fire bypass	B6
152	Refrigeration	27	382	Loss of supervision - RPM	70	572	24Hr. zone bypass	B7
153	Loss of heat	28	383	Sensor tamper	71	573	Burglary bypass	B8
154	Water leakage	29	384	RF transmitter low battery	72	574	Group bypass	B9
155	Foil break	2A	385	Smoke detector Hi sensitivity	73	575	Swinger bypass	BA
156	Day trouble	2B	386	Smoke detector Low sensitivity	74	576	Access zone shunt	BB
157	Low bottled gas level	2C	387	Intrusion detector Hi sensitivity	75	577	Access point bypass	BC
158	High temperature	2D	388	Intrusion detector Low sensitivity	76	Test/Misc. - 600		
159	Low temperature	2E	389	Sensor self-test failure	77	601	Manual trigger test	BD
161	Loss of air flow	2F	391	Sensor watch trouble	78	602	Periodic test report	BE
162	Carbon monoxide detected	30	392	Drift compensation error	79	603	Periodic RF transmission	BF
163	Tank level	31	393	Maintenance alert	7A	604	Fire test	C0
Fire Supervisory - 200 and 210			Open/Close - 400			605	Status report to follow	C1
200	Fire supervisory	32	400	Open/Close	7B	606	Listen-in to follow	C2
201	Low water pressure	33	401	Open/Close by user	7C	607	Walk test mode	C3
202	Low CO ₂	34	402	Group open/close	7D	608	Periodic test - system trouble present	C4
203	Gate valve sensor	35	403	Automatic open/close	7E	609	Video transmitter active	C5
204	Low water level	36	406	Cancel	7F	611	Point test OK	C6
205	Pump activated	37	407	Remote arm/disarm	80	612	Point not tested	C7
206	Pump failure	38	408	Quick arm	81	613	Intrusion zone walk tested	C8
System Troubles - 300 and 310			409	Keyswitch open/close	82	614	Fire zone walk tested	C9
300	System trouble	39	Remote Access - 410			615	Panic zone walk tested	CA
301	AC loss	3A	411	Call back request made	83	616	Service request	CB
302	Low system battery	3B	412	Success - download access	84	621	Event log reset	CC
303	RAM checksum bad	3C	413	Unsuccessful access	85	622	Event log 50% full	CD
304	ROM checksum	3D	414	System shutdown	86	623	Event log 90% full	CE
305	System reset	3E	415	Dialer shutdown	87	624	Event log overflow	CF
306	Panel program changed	3F	416	Successful upload	88	625	Time/Date reset	D0
307	Self-test failure	40	Access Control - 420 and 430			626	Time/Date inaccurate	D1
308	System shutdown	41	421	Access denied	89	627	Program mode entry	D2
309	Battery test failure	42	422	Access report by user	8A	628	Program mode exit	D3
310	Ground fault	43	423	Forced access	8B	629	32-hour event log marker	D4
311	Battery missing/dead	44	424	Egress denied	8C	630	Schedule change	D5
312	Power supply over current limit	45	425	Egress granted	8D	631	Exception schedule change	D6
313	Engineer reset	46	426	Access door propped open	8E	632	Access schedule change	D7
Sounder/Relay Troubles - 320			427	Access point door status monitor trouble	8F	654	System inactivity	D8
320	Sounder/relay	47	428	Access point request to exit	90			

Automatic Report Code List

System Event	Default Contact ID Report Code	Default SIA Report Code
Arming with User Code (##)	3 4A1 - Close by user	CL - Closing report
Auto arming	3 4A3 - Automatic close	CA - Automatic closing
Late to close	3 452 - Late to close	OT - Late to close
No movement	3 452 - Late to close	NA - No activity
Partial arming	1 456 - Group bypass	CG - Close area
Quick arming	3 4A8 - Quick arm	CL - Closing report
Arm with PC software	3 4A7 - Remote arm/disarm	CQ - Remote arming
Keyswitch arming	3 4A9 - Keyswitch arming	CS - Keyswitch arming
Disarm with User Code (##)	1 4A1 - Open by user	OP - Opening report
Disarm after alarm* with User Code (##)	1 4A1 - Open by user	OP - Opening report
Cancel alarm** with User Code (##)	1 4A6 - Cancel by user	OR - Disarm from alarm
Auto-arming cancellation	1 464 - Deferred open/close	CE - Closing extend
Disarm with PC software	1 4A7 - Remote arm/disarm	OQ - Remote disarming
Disarm after an alarm with PC software	1 4A7 - Remote arm/disarm	OR - Disarm from alarm
Cancel alarm with PC software	1 4A6 - Cancel by user	OR - Disarm from alarm
Cancel paramedic alarm	1 4A6 - Cancel by user	MH - Medical alarm restore
Keyswitch disarm	1 4A9 - Keyswitch disarm	OS - Keyswitch disarm
Keyswitch disarm after alarm	1 4A1 - Keyswitch disarm after alarm	OS - Keyswitch disarm after alarm
Keyswitch cancel alarm	1 4A6 - Keyswitch cancel alarm	OS - Keyswitch cancel alarm
Zone bypassed (##)	1 57A - Zone bypass	UB - Untyped zone bypass
Zone alarm (##)	1 13A - Burglary alarm	BA - Burglary alarm
Fire alarm (##)	1 11A - Fire alarm	FA - Fire alarm
Zone alarm restore (##)	3 13A - Burglary alarm restore	BH - Burglary alarm restore
Fire alarm restore (##)	3 11A - Fire alarm restore	FH - Fire alarm restore
24Hr Gas Alarm (##)	1 151 - Gas detected	GA - Gas Alarm
24Hr Heat Alarm (##)	1 153 - Loss of heat	KA - Heat Alarm
24Hr Water Alarm (##)	1 154 - Water leakage	WA - Water Alarm
24Hr Freeze Alarm (##)	1 152 - Refrigeration	ZA - Freeze Alarm
24Hr Gas Alarm Restore (##)	3 151 - Gas restore	GR - Gas Alarm Restore
24Hr Heat Alarm Restore (##)	3 153 - Heat restore	KR - Heat Alarm Restore
24Hr Water Alarm Restore (##)	3 154 - Water restore	WR - Water Alarm Restore
24Hr Freeze Alarm Restore (##)	3 152 - Freeze restore	ZR - Freeze Alarm Restore
24Hr Hold-up Alarm	1 12A - Panic Alarm	PA - Panic Alarm
24Hr Hold-up Alarm Restore	3 12A - Panic Alarm Restore	PR - Panic Restore
Panic 1 - emergency	1 12A - Panic alarm	PA - Panic alarm
Panic 2 - medical	1 1A - Medical alarm	MA - Medical alarm
Panic 3 - fire	1 115 - Pull station	FA - Fire alarm
Recent closing	3 459 - Open/Close	CR - Recent closing
Global zone shutdown	1 575 - Group bypass	CG - Close area
Duress alarm	1 121 - Duress	HA - Hold-up alarm
Keypad lockout	1 421 - Access denied	JA - User code tamper
Zone shutdown (##)	1 57A - Zone bypass	UB - Untyped zone bypass
Zone tampered (##)	1 144 - Sensor tamper	TA - Tamper alarm
Zone tamper restore (##)	3 144 - Sensor tamper restore	TR - Tamper restoral
TLM Trouble	1 351 - Telco 1 fault	LT - Phone Line Trouble
AC failure	1 3A1 - AC loss	AT - AC trouble
Battery failure	1 3A9 - Battery test failure	YT - System battery trouble
Auxiliary supply trouble	1 3AA - System trouble	YP - Power supply trouble
Bell output current limit	1 321 - Bell 1	YA - Bell fault
Bell absent	1 321 - Bell 1	YA - Bell fault
Clock lost	1 626 - Time/date inaccurate	JT - Time changed
Fire loop trouble	1 373 - Fire trouble	FT - Fire trouble
Communication fail	1 354 - Communication fail	YC - Fail to communicate
RF jamming	1 344 - RF receiver jam detection	XQ - RF Jamming
GSM/GPRS module RF interference	1 552 - Radio transmitter disabled	YS - Communication trouble
GSM/GPRS network failure	1 552 - Radio transmitter disabled	YS - Communication trouble
GSM/GPRS supervision lost	1 552 - Radio transmitter disabled	YS - Communication trouble
GSM/GPRS fail to communicate	1 354 - Communication fails	YC - Fail to communicate
IP network failure	1 552 - Radio transmitter disabled	YS - Communication trouble
IP supervision lost	1 552 - Radio transmitter disabled	YS - Communication trouble
IP fail to communicate	1 354 - Communication fails	YC - Fail to communicate
TLM trouble restore	3 351 - Telco 1 fault restore	LR - Phone line restoral
AC failure restore	3 3A1 - AC loss restore	AR - AC restoral
Battery failure restore	3 3A9 - Battery test restore	YR - System battery restoral
Auxiliary supply trouble restore	3 3AA - System trouble restore	YQ - Power supply restored
Bell output current limit restore	3 321 - Bell 1 restore	YH - Bell restored
Bell absent restore	3 321 - Bell 1 restore	YH - Bell restored
Clock programmed	3 625 - Time/date reset	JT - Time changed
Fire loop trouble restore	3 373 - Fire trouble restore	FJ - Fire trouble restore
Fail to communicate with monitoring station	3 354 - Fail to communicate	YK - Communication fails

* An armed system is or was in alarm and was disarmed by a user.

** A disarmed system is or was in alarm (e.g. 24Hr. zone) and was disarmed by a user.

System Event	Default Contact ID Report Code	Default SIA Report Code
RF jamming	3 344 - RF receiver jam detection	XH - RF Jamming Restoral
GSM/GPRS module Rf interference restore	3 552 - Radio transmitter restore	YK - Communication restore
GSM/GPRS network restore	3 552 - Radio transmitter restore	YK - Communication restore
GSM/GPRS supervision restore	3 552 - Radio transmitter restore	YK - Communication restore
GSM/GPRS fail to communicate restore	3 354 - Communication restore	YK - Fail to communicate restore
IP network restore	3 552 - Radio transmitter restore	YK - Communication restore
IP supervision restore	3 552 - Radio transmitter restore	YK - Communication restore
IP fail to communicate restore	3 354 - Communication restore	YK - Fail to communicate restore
Combus fault	1 333 - Expansion module failure	ET - Expansion trouble
Module tamper	1 341 - Expansion module tamper	TA - Tamper alarm
Module AC fail	1 342 - AC failure on module	AT - Module AC fail
Module battery fail	1 338 - Battery failure on module	YT - Module battery fail
Bus fault restore	3 333 - Expansion module failure restore	ER - Expansion restoral
Module tamper restore	3 341 - Expansion module tamper restore	TR - Tamper restoral
Module AC fail restore	3 342 - AC restored on module	AR - Module AC fail restore
Module battery fail restore	3 338 - Battery failure on module	YR - Module battery fail restore
Cold start	1 3A8 - System shutdown	RR - Power up
Test report engaged	1 6A2 - Periodic test report	TX - Test report
PC software communication finished	1 412 - Successful - download access	RS - Remote program success
Installer on site	1 627 - Program mode entry	LB - Local program
Installer programming finished	1 628 - Program mode exit	LS - Local program success
Maintenance in	1 627 - Program mode entry	LB - Local program
Maintenance out	1 628 - Program mode exit	LS - Local program success
Closing delinquency	1 654 - System inactivity	CD - System inactivity
Manual trigger test in	1 6A1 - Manual trigger test in	TS - Manual trigger test in
Manual trigger test out	3 6A1 - Manual trigger test out	TS - Manual trigger test out
Exit error	1 374 - Exit error	EE - Exit error
RF module low battery	1 384 - RF transmitter low battery	XT - Transmitter battery trouble
RF module battery restore	3 384 - RF transmitter battery restore	XR - Transmitter battery restoral
RF zone supervision lost	1 381 - Loss of supervision - RF	US - Untype zone supervision
RF zone supervision restore	3 381 - Supervision restore - RF	UR - Untyped zone restoral
RF module supervision lost	1 381 - Loss of supervision- RF	US - Untype zone supervision
RF module supervision restore	3 381 - Loss of supervision- RF restore	UR - Untyped zone restoral
RF module tamper	1 145 - Expansion module tamper	ES - Expansion device tamper
RF module tamper restore	3 145 - Expansion module tamper restore	EJ - Expansion device restore
Paramedic alarm	1 1AA - Medical	MA - Medical alarm
Zone forced	1 57A - Zone forced	XW - Zone forced
Zone included	3 57A - Zone included	UU - Zone included

Installer Function Keys

Use the following instructions to access the Installer Function features.

Function	Action	Description
Test Report	[ENTER]+[INSTALLER CODE] + [MEM]	Send the "Test Report" report code programmed in section [875] (page 38) to the monitoring station
Cancel Communication	[ENTER]+[INSTALLER CODE] + [STAY]	Cancels all communication with the WinLoad / BabyWare software or with the monitoring station until the next reportable event
Answer WinLoad / BabyWare Software	[ENTER]+[INSTALLER CODE] + [SLEEP]	Will force the console to answer an incoming call from the monitoring station that is using the WinLoad / BabyWare software
Call WinLoad / BabyWare Software	[ENTER]+[INSTALLER CODE] + [BYP]	Will dial the PC telephone number programmed in section [915] (page 22) in order to initiate communication with a computer using the WinLoad / BabyWare software
Installer Test Mode	[ENTER]+[INSTALLER CODE] + [TBL]	The installer test mode will allow you to perform walk tests where the siren will squawk to indicate opened zones. Press the [TBL] key again to exit

Trouble Display

Press the **[TBL]** key to view the Trouble Display. Please note that the keypad can be programmed to emit a **BEEP** every 5 seconds whenever a new trouble condition has occurred. Press the **[TBL]** key to stop the beeping.

To view the sub-menu, press the corresponding key in the main menu.

Main Menu Trouble	Sub-Menu Trouble Menu
[1] Wireless zone low battery	[1] to [32] Zones in low battery
[2] Power trouble	[1] Low/No battery on the control panel [2] AC failure on control panel [3] Auxiliary overload on control panel [4] Wireless keypad AC failure [5] Wireless keypad battery failure [6] Wireless repeater AC failure [7] Wireless repeater battery failure [8] Wireless siren AC failure [9] Wireless siren battery failure
[3] Bell trouble	[1] Bell disconnect on control panel [2] Bell overload on control panel
[4] Communication trouble	[1] Telephone Line Monitoring on control panel [2] Fail to communicate on Monitoring Telephone 1 on control panel [3] Fail to communicate on Monitoring Telephone 2 on control panel [5] Fail to communicate on voice telephone on control panel [6] Fail to communicate with PC on control panel [7] Fail to communicate with IP receiver 1 or 2 (GPRS) [8] Fail to communicate with IP receiver 1 or 2 (IP) [9] GSM no service (GSM network failure) [10] IP Module No Service (network failure) [STAY] GSM RF jamming [OFF] IP Receiver Unregistered (IP/GPRS)
[5] Tamper and zone wiring failure	[1] to [32] Zones in tamper and zone wiring failure
[6] Module tamper trouble	[1] 2WPGM [2] Keypad bus [3] ZX8 bus module [4] RTX3 bus module [5] Wireless siren
[7] Fire loop trouble	[1] to [32] Zones in fire loop trouble
[8] Timer loss	
[9] Wireless zone supervision loss	[1] to [32] Zones in supervision lost [STAY] RF jamming trouble
[0 (10)] or [10] Module supervision loss	[1] 2WPGM [2] Keypad bus (Panel reset will not clear this trouble, clear it in section [955]) [3] ZX8 bus module [4] RTX3 bus module [5] Wireless keypad [6] Wireless repeater [7] N/A [8] VDMP3 [9] PCS Series (GPRS) [10] IP100 [STAY] Wireless siren
[16] Keypad fault (K32 / K32RF / K37 / K35 only)	
[17] Upgrade panel to V3.2 or higher (K37 only)	
[SLEEP] Keypad fault (K636 / K10V/H only)	

Wireless Repeater Programming (RPT1)

Wireless Repeater Assignment

Section Wireless Repeater Serial Number

[545] Repeater 1 / / / / / / /
 [546] Repeater 2 / / / / / / /

NOTE: For automatic assignment, press the wireless repeater's anti-tamper switch while in the respective section.

Section Wireless Repeater Labels

[568] Repeater 1 /
 [569] Repeater 2 /

NOTE: For label character tables, see *LCD Keypad Labels (K32LCD)* on page 47.

[965] Reset Wireless Repeater/Siren Labels

Option OFF Disabled ON Enabled
 [6] Reset wireless repeater/siren labels*

* Ensure all other options are deselected. Press [ENTER] to reset the respective set of labels to default before exiting the section.

NOTE: This section also applies to wireless siren programming see page 46.

Wireless Repeater Signal Strength

Section

[548] Wireless Repeater 1 Signal Strength
 [549] Wireless Repeater 2 Signal Strength

Signal Strength Indicator	8 to 10 / 3 beeps = Best signal	5 to 7 / 2 beeps = Average signal	1 to 4 / 1 beep = Weak signal (Relocate)
----------------------------------	---------------------------------	-----------------------------------	--

NOTE: To view the wireless repeater's signal strength, press the wireless repeater's anti-tamper switch while in the respective section.

[700] RF Jamming Supervision

Option OFF Disabled ON Enabled
 [5] RF jamming supervision

Wireless Repeater Options

NOTE: Remote control signals are always repeated.

Option	RPT1 #1 [551]		RPT1 #2 [561]	
	OFF	ON	OFF	ON
[1] Repeat Wireless Keypad 1 Signals	<input type="checkbox"/>	<input type="checkbox"/>	<input type="checkbox"/>	<input type="checkbox"/>
[2] Repeat Wireless Keypad 2 Signals	<input type="checkbox"/>	<input type="checkbox"/>	<input type="checkbox"/>	<input type="checkbox"/>
[3] Repeat Wireless Keypad 3 Signals	<input type="checkbox"/>	<input type="checkbox"/>	<input type="checkbox"/>	<input type="checkbox"/>
[4] Repeat Wireless Keypad 4 Signals	<input type="checkbox"/>	<input type="checkbox"/>	<input type="checkbox"/>	<input type="checkbox"/>
[5] Repeat Wireless Keypad 5 Signals	<input type="checkbox"/>	<input type="checkbox"/>	<input type="checkbox"/>	<input type="checkbox"/>
[6] Repeat Wireless Keypad 6 Signals	<input type="checkbox"/>	<input type="checkbox"/>	<input type="checkbox"/>	<input type="checkbox"/>
[7] Repeat Wireless Keypad 7 Signals	<input type="checkbox"/>	<input type="checkbox"/>	<input type="checkbox"/>	<input type="checkbox"/>
[8] Repeat Wireless Keypad 8 Signals	<input type="checkbox"/>	<input type="checkbox"/>	<input type="checkbox"/>	<input type="checkbox"/>

Option	RPT1 #1 [552]		RPT1 #2 [562]	
	OFF	ON	OFF	ON
[1] Repeat Wireless Zone 1 Signals	<input type="checkbox"/>	<input type="checkbox"/>	<input type="checkbox"/>	<input type="checkbox"/>
[2] Repeat Wireless Zone 2 Signals	<input type="checkbox"/>	<input type="checkbox"/>	<input type="checkbox"/>	<input type="checkbox"/>
[3] Repeat Wireless Zone 3 Signals	<input type="checkbox"/>	<input type="checkbox"/>	<input type="checkbox"/>	<input type="checkbox"/>
[4] Repeat Wireless Zone 4 Signals	<input type="checkbox"/>	<input type="checkbox"/>	<input type="checkbox"/>	<input type="checkbox"/>
[5] Repeat Wireless Zone 5 Signals	<input type="checkbox"/>	<input type="checkbox"/>	<input type="checkbox"/>	<input type="checkbox"/>
[6] Repeat Wireless Zone 6 Signals	<input type="checkbox"/>	<input type="checkbox"/>	<input type="checkbox"/>	<input type="checkbox"/>
[7] Repeat Wireless Zone 7 Signals	<input type="checkbox"/>	<input type="checkbox"/>	<input type="checkbox"/>	<input type="checkbox"/>
[8] Repeat Wireless Zone 8 Signals	<input type="checkbox"/>	<input type="checkbox"/>	<input type="checkbox"/>	<input type="checkbox"/>

		RPT1 #1 [553]		RPT1 #2 [563]	
Option		OFF	ON	OFF	ON
[1]	Repeat Wireless Zone 9 Signals	<input type="checkbox"/>	<input type="checkbox"/>	<input type="checkbox"/>	<input type="checkbox"/>
[2]	Repeat Wireless Zone 10 Signals	<input type="checkbox"/>	<input type="checkbox"/>	<input type="checkbox"/>	<input type="checkbox"/>
[3]	Repeat Wireless Zone 11 Signals	<input type="checkbox"/>	<input type="checkbox"/>	<input type="checkbox"/>	<input type="checkbox"/>
[4]	Repeat Wireless Zone 12 Signals	<input type="checkbox"/>	<input type="checkbox"/>	<input type="checkbox"/>	<input type="checkbox"/>
[5]	Repeat Wireless Zone 13 Signals	<input type="checkbox"/>	<input type="checkbox"/>	<input type="checkbox"/>	<input type="checkbox"/>
[6]	Repeat Wireless Zone 14 Signals	<input type="checkbox"/>	<input type="checkbox"/>	<input type="checkbox"/>	<input type="checkbox"/>
[7]	Repeat Wireless Zone 15 Signals	<input type="checkbox"/>	<input type="checkbox"/>	<input type="checkbox"/>	<input type="checkbox"/>
[8]	Repeat Wireless Zone 16 Signals	<input type="checkbox"/>	<input type="checkbox"/>	<input type="checkbox"/>	<input type="checkbox"/>

		RPT1 #1 [554]		RPT1 #2 [564]	
Option		OFF	ON	OFF	ON
[1]	Repeat Wireless Zone 17 Signals	<input type="checkbox"/>	<input type="checkbox"/>	<input type="checkbox"/>	<input type="checkbox"/>
[2]	Repeat Wireless Zone 18 Signals	<input type="checkbox"/>	<input type="checkbox"/>	<input type="checkbox"/>	<input type="checkbox"/>
[3]	Repeat Wireless Zone 19 Signals	<input type="checkbox"/>	<input type="checkbox"/>	<input type="checkbox"/>	<input type="checkbox"/>
[4]	Repeat Wireless Zone 20 Signals	<input type="checkbox"/>	<input type="checkbox"/>	<input type="checkbox"/>	<input type="checkbox"/>
[5]	Repeat Wireless Zone 21 Signals	<input type="checkbox"/>	<input type="checkbox"/>	<input type="checkbox"/>	<input type="checkbox"/>
[6]	Repeat Wireless Zone 22 Signals	<input type="checkbox"/>	<input type="checkbox"/>	<input type="checkbox"/>	<input type="checkbox"/>
[7]	Repeat Wireless Zone 23 Signals	<input type="checkbox"/>	<input type="checkbox"/>	<input type="checkbox"/>	<input type="checkbox"/>
[8]	Repeat Wireless Zone 24 Signals	<input type="checkbox"/>	<input type="checkbox"/>	<input type="checkbox"/>	<input type="checkbox"/>

		RPT1 #1 [555]		RPT1 #2 [565]	
Option		OFF	ON	OFF	ON
[1]	Repeat Wireless Zone 25 Signals	<input type="checkbox"/>	<input type="checkbox"/>	<input type="checkbox"/>	<input type="checkbox"/>
[2]	Repeat Wireless Zone 26 Signals	<input type="checkbox"/>	<input type="checkbox"/>	<input type="checkbox"/>	<input type="checkbox"/>
[3]	Repeat Wireless Zone 27 Signals	<input type="checkbox"/>	<input type="checkbox"/>	<input type="checkbox"/>	<input type="checkbox"/>
[4]	Repeat Wireless Zone 28 Signals	<input type="checkbox"/>	<input type="checkbox"/>	<input type="checkbox"/>	<input type="checkbox"/>
[5]	Repeat Wireless Zone 29 Signals	<input type="checkbox"/>	<input type="checkbox"/>	<input type="checkbox"/>	<input type="checkbox"/>
[6]	Repeat Wireless Zone 30 Signals	<input type="checkbox"/>	<input type="checkbox"/>	<input type="checkbox"/>	<input type="checkbox"/>
[7]	Repeat Wireless Zone 31 Signals	<input type="checkbox"/>	<input type="checkbox"/>	<input type="checkbox"/>	<input type="checkbox"/>
[8]	Repeat Wireless Zone 32 Signals	<input type="checkbox"/>	<input type="checkbox"/>	<input type="checkbox"/>	<input type="checkbox"/>

		RPT1 #1 [556]		RPT1 #2 [566]	
Option		OFF	ON	OFF	ON
[1]	Repeat Wireless 2-Way PGM 1 Signals	<input type="checkbox"/>	<input type="checkbox"/>	<input type="checkbox"/>	<input type="checkbox"/>
[2]	Repeat Wireless 2-Way PGM 2 Signals	<input type="checkbox"/>	<input type="checkbox"/>	<input type="checkbox"/>	<input type="checkbox"/>
[3]	Repeat Wireless 2-Way PGM 3 Signals	<input type="checkbox"/>	<input type="checkbox"/>	<input type="checkbox"/>	<input type="checkbox"/>
[4]	Repeat Wireless 2-Way PGM 4 Signals	<input type="checkbox"/>	<input type="checkbox"/>	<input type="checkbox"/>	<input type="checkbox"/>
[5]	Repeat Wireless 2-Way PGM 5 Signals	<input type="checkbox"/>	<input type="checkbox"/>	<input type="checkbox"/>	<input type="checkbox"/>
[6]	Repeat Wireless 2-Way PGM 6 Signals	<input type="checkbox"/>	<input type="checkbox"/>	<input type="checkbox"/>	<input type="checkbox"/>
[7]	Repeat Wireless 2-Way PGM 7 Signals	<input type="checkbox"/>	<input type="checkbox"/>	<input type="checkbox"/>	<input type="checkbox"/>
[8]	Repeat Wireless 2-Way PGM 8 Signals	<input type="checkbox"/>	<input type="checkbox"/>	<input type="checkbox"/>	<input type="checkbox"/>

		RPT1 #1 [557]		RPT1 #2 [567]	
Option		OFF	ON	OFF	ON
[1]	Repeat Wireless 2-Way PGM 9 Signals	<input type="checkbox"/>	<input type="checkbox"/>	<input type="checkbox"/>	<input type="checkbox"/>
[2]	Repeat Wireless 2-Way PGM 10 Signals	<input type="checkbox"/>	<input type="checkbox"/>	<input type="checkbox"/>	<input type="checkbox"/>
[3]	Repeat Wireless 2-Way PGM 11 Signals	<input type="checkbox"/>	<input type="checkbox"/>	<input type="checkbox"/>	<input type="checkbox"/>
[4]	Repeat Wireless 2-Way PGM 12 Signals	<input type="checkbox"/>	<input type="checkbox"/>	<input type="checkbox"/>	<input type="checkbox"/>
[5]	Repeat Wireless 2-Way PGM 13 Signals	<input type="checkbox"/>	<input type="checkbox"/>	<input type="checkbox"/>	<input type="checkbox"/>
[6]	Repeat Wireless 2-Way PGM 14 Signals	<input type="checkbox"/>	<input type="checkbox"/>	<input type="checkbox"/>	<input type="checkbox"/>
[7]	Repeat Wireless 2-Way PGM 15 Signals	<input type="checkbox"/>	<input type="checkbox"/>	<input type="checkbox"/>	<input type="checkbox"/>
[8]	Repeat Wireless 2-Way PGM 16 Signals	<input type="checkbox"/>	<input type="checkbox"/>	<input type="checkbox"/>	<input type="checkbox"/>

Wireless Transmitter Signal Strength

Section	Section	Section	Section
[101] Zone 1	[109] Zone 9	[117] Zone 17	[125] Zone 25
[102] Zone 2	[110] Zone 10	[118] Zone 18	[126] Zone 26
[103] Zone 3	[111] Zone 11	[119] Zone 19	[127] Zone 27
[104] Zone 4	[112] Zone 12	[120] Zone 20	[128] Zone 28
[105] Zone 5	[113] Zone 13	[121] Zone 21	[129] Zone 29
[106] Zone 6	[114] Zone 14	[122] Zone 22	[130] Zone 30
[107] Zone 7	[115] Zone 15	[123] Zone 23	[131] Zone 31
[108] Zone 8	[116] Zone 16	[124] Zone 24	[132] Zone 32

Signal Strength Indicator | 8 to 10 / 3 beeps = Best signal | 5 to 7 / 2 beeps = Average signal | 1 to 4 / 1 beep = Weak signal (Relocate)

NOTE: To view the wireless transmitter signal strength, press the wireless transmitter's anti-tamper switch while in the respective section.

Wireless Keypad Programming (K32RF / K37)

NOTE: For standard keypad programming, see page 18.

Automatic Wireless Keypad Assignment

After panel power-up, the control panel will open a 10 minute window for Automatic Assignment. Press and hold the [⏏] and [BYP] key for three seconds on the respective keypad. The keypad is assigned to the control panel. Up to 8 wireless keypads can be assigned within the ten minute window.

Compatibility Check (K37 only)

If the K37 is not compatible with the current panel version, the following Trouble will be displayed:

[TROUBLE : flash] [17 : on] If this occurs, update your MG/SP panel to version 3.2 or higher.

Wireless Keypad Labels

[965] Wireless Keypad Labels Reset

Option **OFF** Disabled **ON** Enabled

[7] Reset wireless keypad labels*

* Ensure all other options are deselected. Press [ENTER] to reset the respective set of labels to default before exiting the section.

Section	Kpd.	Label	Section	Kpd.	Label
[599]	1	____/____/____/____/____/____/____/____	[603]	5	____/____/____/____/____/____/____/____
[600]	2	____/____/____/____/____/____/____/____	[604]	6	____/____/____/____/____/____/____/____
[601]	3	____/____/____/____/____/____/____/____	[605]	7	____/____/____/____/____/____/____/____
[602]	4	____/____/____/____/____/____/____/____	[606]	8	____/____/____/____/____/____/____/____

NOTE: For label character tables, see *LCD Keypad Labels (K32LCD)* on page 47.

Standard Wireless Keypad Assignment

Section	Wireless Keypad Serial Number
[571]	Keypad 1 _____/_____/_____/_____/_____/_____/_____/_____/_____/_____
[572]	Keypad 2 _____/_____/_____/_____/_____/_____/_____/_____/_____/_____
[573]	Keypad 3 _____/_____/_____/_____/_____/_____/_____/_____/_____/_____
[574]	Keypad 4 _____/_____/_____/_____/_____/_____/_____/_____/_____/_____
[575]	Keypad 5 _____/_____/_____/_____/_____/_____/_____/_____/_____/_____
[576]	Keypad 6 _____/_____/_____/_____/_____/_____/_____/_____/_____/_____
[577]	Keypad 7 _____/_____/_____/_____/_____/_____/_____/_____/_____/_____
[578]	Keypad 8 _____/_____/_____/_____/_____/_____/_____/_____/_____/_____

NOTE: Enter serial number or press and hold the [⏏] and [BYP] key for three seconds.

Wireless Keypad Signal Strength

Section

[591]	Wireless Keypad 1 Signal Strength
[592]	Wireless Keypad 2 Signal Strength
[593]	Wireless Keypad 3 Signal Strength
[594]	Wireless Keypad 4 Signal Strength
[595]	Wireless Keypad 5 Signal Strength
[596]	Wireless Keypad 6 Signal Strength
[597]	Wireless Keypad 7 Signal Strength
[598]	Wireless Keypad 8 Signal Strength

Signal Strength Indicator | 8 to 10 / 3 beeps = Best signal | 5 to 7 / 2 beeps = Average signal | 1 to 4 / 1 beep = Weak signal (Relocate)

NOTE: To view the wireless keypad's signal strength, press the key.

Wireless Repeater / Keypad Options

[587] Wireless Repeater / Keypad Options

Option	OFF	ON
[1] Repeater 1 Supervision	<input type="checkbox"/> Disabled	<input checked="" type="checkbox"/> Enabled
[2] Repeater 2 Supervision	<input type="checkbox"/> Disabled	<input checked="" type="checkbox"/> Enabled
[8] Live Display Mode	<input type="checkbox"/> Disabled	<input checked="" type="checkbox"/> Enabled

[588] Wireless Keypad Options

Option	OFF	ON
[1] Keypad 1 Supervision	<input type="checkbox"/> Disabled	<input checked="" type="checkbox"/> Enabled
[2] Keypad 2 Supervision	<input type="checkbox"/> Disabled	<input checked="" type="checkbox"/> Enabled
[3] Keypad 3 Supervision	<input type="checkbox"/> Disabled	<input checked="" type="checkbox"/> Enabled
[4] Keypad 4 Supervision	<input type="checkbox"/> Disabled	<input checked="" type="checkbox"/> Enabled
[5] Keypad 5 Supervision	<input type="checkbox"/> Disabled	<input checked="" type="checkbox"/> Enabled
[6] Keypad 6 Supervision	<input type="checkbox"/> Disabled	<input checked="" type="checkbox"/> Enabled
[7] Keypad 7 Supervision	<input type="checkbox"/> Disabled	<input checked="" type="checkbox"/> Enabled
[8] Keypad 8 Supervision	<input type="checkbox"/> Disabled	<input checked="" type="checkbox"/> Enabled

Wireless Siren Programming

Wireless Siren Labels

[965] Wireless Siren/Repeater Labels Reset

Option	OFF	ON
[7] Reset wireless siren/repeater labels*	<input type="checkbox"/> Disabled	<input checked="" type="checkbox"/> Enabled

* Ensure all other options are deselected. Press [ENTER] to reset the respective set of labels to default before exiting the section.

NOTE: This section also applies to wireless repeater programming on page 43.

Section	Siren	Label	Section	Siren	Label
[691]	1	_/ / _ / / _ / / _ / / _ / / _ / / _ / / _ / / _ / / _ / / _ / / _ / / _ / / _ / /	[693]	3	_/ / _ / / _ / / _ / / _ / / _ / / _ / / _ / / _ / / _ / / _ / / _ / / _ / /
[692]	2	_/ / _ / / _ / / _ / / _ / / _ / / _ / / _ / / _ / / _ / / _ / / _ / / _ / /	[694]	4	_/ / _ / / _ / / _ / / _ / / _ / / _ / / _ / / _ / / _ / / _ / / _ / / _ / /

NOTE: For label character tables, see *LCD Keypad Labels (K32LCD)* on page 47.

Wireless Siren Assignment

Section	Wireless Siren Serial Number
[683]	Siren 1 _ / _ / _ / _ / _ / _ /
[684]	Siren 2 _ / _ / _ / _ / _ / _ /
[685]	Siren 3 _ / _ / _ / _ / _ / _ /
[686]	Siren 4 _ / _ / _ / _ / _ / _ /

Wireless Siren Signal Strength

Section

- [687]** Wireless Siren 1 Signal Strength
- [688]** Wireless Siren 2 Signal Strength
- [689]** Wireless Siren 3 Signal Strength
- [690]** Wireless Siren 4 Signal Strength

Signal Strength Indicator	8 to 10 / 3 beeps = Best signal	5 to 7 / 2 beeps = Average signal	1 to 4 / 1 beep = Weak signal (Relocate)
----------------------------------	---------------------------------	-----------------------------------	--

Wireless Siren Options

[587] Wireless Siren Supervision

Option

- [3]** Wireless Siren 1 Supervision
- [4]** Wireless Siren 2 Supervision
- [5]** Wireless Siren 3 Supervision
- [6]** Wireless Siren 4 Supervision

OFF

- Disabled
- Disabled
- Disabled
- Disabled

ON

- Enabled
- Enabled
- Enabled
- Enabled

[695] Cancel Wireless Siren Tamper Supervision

Press **[ENTER]** to disable wireless siren tamper supervision for 30 minutes.

LCD Keypad Labels (K32LCD)

Use the following information to program system labels using an LCD keypad.

Input Keys

Special Function Keys	
Key	Function
[STAY]	Insert space
[SLEEP]	Delete
[ARM]	Delete whole entry
[OFF]	Toggle numeric/alphanumeric keys
[BYP]	Toggle lower case/upper case
[MEM]	Special characters

Alphanumeric Key Input	
[1]	A / B / C
[2]	D / E / F
[3]	G / H / I
[4]	J / K / L
[5]	M / N / O
[6]	P / Q / R
[7]	S / T / U
[8]	V / W / X
[9]	Y / Z

Special Characters and Keypad Letter Assignment

Polish / Hungarian / Turkish Special Character Catalogue

Polish	⁰⁰¹ Ż	⁰⁰² Ć	⁰⁰³ ą	⁰⁰⁴ ę	⁰⁰⁵ ź	⁰⁰⁶ ł	⁰⁰⁷ ś
Hungarian	⁰⁰¹ Á	⁰⁰² Ú	⁰⁰³ Ö				
Turkish	⁰⁰¹ Ü						

Special Character Catalogue

032	048	064	080	096	112	128	144	160	176	192	208
0	@	P	`	p	Ù	Ê	à	§	∅		·
033	049	065	081	097	113	129	145	161	177	193	209
!	1	A	Q	a	q	Û	È	î	±	Ł	ˆ
034	050	066	082	098	114	130	146	162	178	194	210
"	2	B	R	b	r	Ú	É	ı	ıj	Đ	°
035	051	067	083	099	115	131	147	163	179	195	211
#	3	C	S	c	s	Û	Ë	í	↑	β	˘
036	052	068	084	100	116	132	148	164	180	196	212
\$	4	D	T	d	t	û	ê	ï	↓	ç	˙
037	053	069	085	101	117	133	149	165	181	197	213
%	5	E	U	e	u	ù	è	ı	↵	®	˜
038	054	070	086	102	118	134	150	166	182	198	214
&	6	F	V	f	v	ú	é	ñ	f	α	÷
039	055	071	087	103	119	135	151	167	183	199	215
'	7	G	W	g	w	ô	ë	ñ	£	☐	«
040	056	072	088	104	120	136	152	168	184	200	216
(8	H	X	h	x	ò	á	ñ	→	μ	»
041	057	073	089	105	121	137	153	169	185	201	217
)	9	I	Y	i	y	ó	ä	ı	↓	ø	†
042	058	074	090	106	122	138	154	170	186	202	218
*	:	J	Z	j	z	õ	â	ı	↑	ÿ	∖
043	059	075	091	107	123	139	155	171	187	203	219
+	;	K	[k	{	ô	â	v	↓	Ä	x
044	060	076	092	108	124	140	156	172	188	204	220
,	<	L	¥	l		ò	à	v	¶	¢	©
045	061	077	093	109	125	141	157	173	189	205	221
-	=	M]	m	}	ó	á	w	½	ã	©
046	062	078	094	110	126	142	158	174	190	206	222
.	>	N	^	n	→	ô	ä	ω	⅓	Ö	☐
047	063	079	095	111	127	143	159	175	191	207	223
/	?	O	_	o	←	ı	Ä	Æ	¼	õ	≡

Hebrew Keypad Letter Assignment

Key	Press key once	Press key twice	Press key three times
[1]	א	ב	ג
[2]	ד	ה	ו
[3]	ז	ח	ט
[4]	י	כ	ל
[5]	מ	נ	ס
[6]	ע	פ	צ
[7]	ק	ר	ש
[8]	ת	י	י
[9]	ך	ש	ת

Hebrew Special Characters Catalogue

032	048	064	080	096	112	128	144	160	176	192	208	224	240
0	א	ב	ג	ד	ה	ו	ז	ח	ט	י	כ	ל	מ
033	049	065	081	097	113	129	145	161	177	193	209	225	241
!	א	ב	ג	ד	ה	ו	ז	ח	ט	י	כ	ל	מ
034	050	066	082	098	114	130	146	162	178	194	210	226	242
"	ב	ר	ב	ר	ג	ר	ג	ד	ר	ד	ע	ו	ז
035	051	067	083	099	115	131	147	163	179	195	211	227	243
#	ג	ס	ס	ט	ט	י	י	כ	י	כ	ל	ל	מ
036	052	068	084	100	116	132	148	164	180	196	212	228	244
\$	ד	ט	ט	י	י	כ	כ	ל	י	ל	מ	נ	נ
037	053	069	085	101	117	133	149	165	181	197	213	229	245
%	ע	ו	ו	ז	ז	ח	ח	ט	ז	ט	י	י	כ
038	054	070	086	102	118	134	150	166	182	198	214	230	246
&	פ	ו	ו	ז	ז	ח	ח	ט	ז	ט	י	י	כ
039	055	071	087	103	119	135	151	167	183	199	215	231	247
'	ג	ו	ו	ז	ז	ח	ח	ט	ז	ט	י	י	כ
040	056	072	088	104	120	136	152	168	184	200	216	232	248
(ח	ח	ח	ט	ט	י	י	כ	י	ל	מ	נ	נ
041	057	073	089	105	121	137	153	169	185	201	217	233	249
)	י	י	י	כ	כ	ל	ל	מ	י	ל	מ	נ	נ
042	058	074	090	106	122	138	154	170	186	202	218	234	250
*	:	י	י	כ	כ	ל	ל	מ	י	ל	מ	נ	נ
043	059	075	091	107	123	139	155	171	187	203	219	235	251
+	;	כ	כ	ל	ל	מ	מ	נ	י	ל	מ	נ	נ
044	060	076	092	108	124	140	156	172	188	204	220	236	252
,	<	ל	ל	מ	מ	נ	נ	ס	י	ל	מ	נ	נ
045	061	077	093	109	125	141	157	173	189	205	221	237	253
-	=	מ	מ	נ	נ	ס	א	ו	½	א	©	©	©
046	062	078	094	110	126	142	158	174	190	206	222	238	254
.	>	נ	נ	ס	ס	ט	א	ו	⅓	ö	☐	☐	☐
047	063	079	095	111	127	143	159	175	191	207	223	239	255
/	?	ו	ו	ז	ז	ח	א	Æ	¼	ö	≡	☐	☐

Greek Keypad Letter Assignment

Key	Press key once	Press key twice	Press key three times
[1]	A	B	Γ
[2]	Δ	E	Z
[3]	H	Θ	I
[4]	K	Λ	M
[5]	N	Ξ	O
[6]	Π	P	Σ
[7]	T	Υ	Φ
[8]	X	Ψ	Ω

Greek Special Characters Catalogue

016	032	048	064	080	096	112	128	144	160	176	192	208	224	240
±	∅	∂	∂	∂	∂	∂	∂	∂	∂	∂	∂	∂	∂	∂
≡	!	1	A	Q	a	q	ü	æ	í	∞	J	+	Y	U
∞	"	2	B	R	b	r	é	æ	ó	∞	∞	∞	∞	∞
∞	#	3	C	S	c	s	á	ó	ú	∞	∞	∞	∞	∞
∞	\$	4	D	T	d	t	ä	ü	ü	∞	∞	∞	∞	∞
∞	%	5	E	U	e	u	à	ü	ü	∞	∞	∞	∞	∞
∞	&	6	F	V	f	v	á	ü	ü	∞	∞	∞	∞	∞
∞	'	7	G	W	g	w	á	ü	ü	∞	∞	∞	∞	∞
∞	(8	H	X	h	x	é	ü	ü	∞	∞	∞	∞	∞
∞)	9	I	Y	i	y	è	ü	ü	∞	∞	∞	∞	∞
∞	*	0	J	Z	j	z	é	ü	ü	∞	∞	∞	∞	∞
∞	+	;	K	[k	[á	ü	ü	∞	∞	∞	∞	∞
∞	=	<	L	/	l	/	á	ü	ü	∞	∞	∞	∞	∞
∞	~	=	M]	m]	á	ü	ü	∞	∞	∞	∞	∞
∞	∞	>	N	^	n	^	á	ü	ü	∞	∞	∞	∞	∞
∞	∞	∞	O	_	o	_	á	ü	ü	∞	∞	∞	∞	∞

Russian Keypad Letter Assignment

Key	Press key once	Press key twice	Press key three times	Press key four times
[1]	A	Б	В	Г
[2]	Д	Е	Ё	Ж
[3]	З	И	Й	К
[4]	Л	М	Н	О
[5]	П	Р	С	Т
[6]	У	Ф	Х	Ц
[7]	Ч	Ш	Щ	Ъ
[8]	Ы	Ь	Э	Ю
[9]	Я			

Russian Special Characters Catalogue

032	048	064	080	096	112	128	144	160	176	192	208	224	240
0	∂	∂	∂	∂	∂	∂	∂	∂	∂	∂	∂	∂	∂
!	1	A	Q	a	q			Г	Я	ш		Ц	1/3
"	2	B	R	b	r			Ё	б	ь		Ш	1/2
#	3	C	S	c	s			Ж	В	Ы	!!	Д	
\$	4	D	T	d	t			З	Г	Ь		Ф	
%	5	E	U	e	u			И	ё	э		и	
&	6	F	V	f	v			Й	ж	ю		ш	
'	7	G	W	g	w			Л	з	л		/	
(8	H	X	h	x			П	и	«		»	
)	9	I	Y	i	y			У	й	»	↑	~	
*	:	J	Z	j	z			Ф	к	»	↓	é	
+	;	K	[k	[10		Ч	л			ç	
,	<	L	/	l	/	12		Ш	М			ij	
-	=	M]	m]	15		Ъ	и	¿		§	
.	>	N	^	n	^	15		Ы	п	f		¶	
/	?	O	_	o	_	15		Э	т	£	■	o	

User Programming



Refer to the *Installer Quick Menu* on page 65 for installer or maintenance code programming.

Refer to the *Master Quick Menu* in the User Guide for user code/remote control programming.

System Codes

[701] Access / Master Code Options

Option

- [1] Access code length
- [2] Lock master code

OFF

- 6 digits
- Disabled

ON

- 4 digits
- Enabled

Section Data

[395]	___/___/___ (147 to lock, other to unlock)
[397]	___/___/___/___/___/___
[398]	___/___/___/___/___/___
[399]	___/___/___/___/___/___

Description

- Installer Code Lock (default 000)
- Installer Code (default = 000000)*
- Maintenance Code (no default)
- System Master Code (default = 123456)*

*4 or 6 digits according to section [701] option [1]. The control panel automatically removes the last 2 digits of the user access code if the length is changed from 6 digits to 4 digits. However, if the user access code length is changed from 4 to 6 digits, the control panel adds 2 digits to the end by using the first two digits.

Maintenance Code Limited Access Table

The Maintenance Code cannot access the following sections:

[395]	Installer code lock	[817]	Backup monitoring station telephone
[397]	Installer code	[910]	Panel ID
[398]	Maintenance code	[911]	PC password
[815]	Monitoring station telephone number 1	[970]	Download memory key into panel
[816]	Monitoring station telephone number 2	[975]	Upload panel into the memory key

User Code Options

User Options

- 1 - Partition 1 Access
- 2 - Partition 2 Access
- 3 - Bypass Programming
- 4 - Stay/Sleep Arming
- 5 - Force Arming (Regular/Sleep/StayArming)
- 6 - Arm Only
- 7 - PGM Activation Only
- 8 - Duress

WARNING: When section [400] is accessed, the panel will copy the saved value of that section to all user options- [404] to [432].

Section	Options
[400]	Default Option 1 2 3 4 5 6 7 8
[401]	System Master: ① ② ③ ④ ⑤ 6 7 8
[402]	Master 1: ① 2 ③ ④ ⑤ 6 7 8
[403]	Master 2: 1 ② ③ ④ ⑤ 6 7 8
[404]	User 4: 1 2 3 4 5 6 7 8
[405]	User 5: 1 2 3 4 5 6 7 8
[406]	User 6: 1 2 3 4 5 6 7 8
[407]	User 7: 1 2 3 4 5 6 7 8
[408]	User 8: 1 2 3 4 5 6 7 8
[409]	User 9: 1 2 3 4 5 6 7 8
[410]	User 10: 1 2 3 4 5 6 7 8
[411]	User 11: 1 2 3 4 5 6 7 8
[412]	User 12: 1 2 3 4 5 6 7 8
[413]	User 13: 1 2 3 4 5 6 7 8
[414]	User 14: 1 2 3 4 5 6 7 8
[415]	User 15: 1 2 3 4 5 6 7 8
[416]	User 16: 1 2 3 4 5 6 7 8

Section	Options
[417]	User 17: 1 2 3 4 5 6 7 8
[418]	User 18: 1 2 3 4 5 6 7 8
[419]	User 19: 1 2 3 4 5 6 7 8
[420]	User 20: 1 2 3 4 5 6 7 8
[421]	User 21: 1 2 3 4 5 6 7 8
[422]	User 22: 1 2 3 4 5 6 7 8
[423]	User 23: 1 2 3 4 5 6 7 8
[424]	User 24: 1 2 3 4 5 6 7 8
[425]	User 25: 1 2 3 4 5 6 7 8
[426]	User 26: 1 2 3 4 5 6 7 8
[427]	User 27: 1 2 3 4 5 6 7 8
[428]	User 28: 1 2 3 4 5 6 7 8
[429]	User 29: 1 2 3 4 5 6 7 8
[430]	User 30: 1 2 3 4 5 6 7 8
[431]	User 31: 1 2 3 4 5 6 7 8
[432]	User 32: 1 2 3 4 5 6 7 8

NOTE: The System Master, Master 1, and Master 2 user code options cannot be modified. However, if partitioning is not enabled, the user code options for Master 2 will match those of Master 1.

User Labels

[965] Reset User Labels

Option

- [2] Reset user labels*

OFF

- Disabled

ON

- Enabled

[965] Reset User Labels

Option

OFF

ON

* Ensure all other options are deselected. Press [ENTER] to reset the respective set of labels to default before exiting the section.

Section	User Label
[511]	1: _/_/_/_/_/_/_/_/_/_/_/_/_/_/_/_
[512]	2: _/_/_/_/_/_/_/_/_/_/_/_/_/_/_/_
[513]	3: _/_/_/_/_/_/_/_/_/_/_/_/_/_/_/_
[514]	4: _/_/_/_/_/_/_/_/_/_/_/_/_/_/_/_
[515]	5: _/_/_/_/_/_/_/_/_/_/_/_/_/_/_/_
[516]	6: _/_/_/_/_/_/_/_/_/_/_/_/_/_/_/_
[517]	7: _/_/_/_/_/_/_/_/_/_/_/_/_/_/_/_
[518]	8: _/_/_/_/_/_/_/_/_/_/_/_/_/_/_/_
[519]	9: _/_/_/_/_/_/_/_/_/_/_/_/_/_/_/_
[520]	10: _/_/_/_/_/_/_/_/_/_/_/_/_/_/_/_
[521]	11: _/_/_/_/_/_/_/_/_/_/_/_/_/_/_/_
[522]	12: _/_/_/_/_/_/_/_/_/_/_/_/_/_/_/_
[523]	13: _/_/_/_/_/_/_/_/_/_/_/_/_/_/_/_
[524]	14: _/_/_/_/_/_/_/_/_/_/_/_/_/_/_/_
[525]	15: _/_/_/_/_/_/_/_/_/_/_/_/_/_/_/_
[526]	16: _/_/_/_/_/_/_/_/_/_/_/_/_/_/_/_

Section	User Label
[527]	17: _/_/_/_/_/_/_/_/_/_/_/_/_/_/_/_
[528]	18: _/_/_/_/_/_/_/_/_/_/_/_/_/_/_/_
[529]	19: _/_/_/_/_/_/_/_/_/_/_/_/_/_/_/_
[530]	20: _/_/_/_/_/_/_/_/_/_/_/_/_/_/_/_
[531]	21: _/_/_/_/_/_/_/_/_/_/_/_/_/_/_/_
[532]	22: _/_/_/_/_/_/_/_/_/_/_/_/_/_/_/_
[533]	23: _/_/_/_/_/_/_/_/_/_/_/_/_/_/_/_
[534]	24: _/_/_/_/_/_/_/_/_/_/_/_/_/_/_/_
[535]	25: _/_/_/_/_/_/_/_/_/_/_/_/_/_/_/_
[536]	26: _/_/_/_/_/_/_/_/_/_/_/_/_/_/_/_
[537]	27: _/_/_/_/_/_/_/_/_/_/_/_/_/_/_/_
[538]	28: _/_/_/_/_/_/_/_/_/_/_/_/_/_/_/_
[539]	29: _/_/_/_/_/_/_/_/_/_/_/_/_/_/_/_
[540]	30: _/_/_/_/_/_/_/_/_/_/_/_/_/_/_/_
[541]	31: _/_/_/_/_/_/_/_/_/_/_/_/_/_/_/_
[542]	32: _/_/_/_/_/_/_/_/_/_/_/_/_/_/_/_

NOTE: For label character tables, see LCD Keypad Labels (K32LCD) on page 47.

User Report Codes (Default = FF)

[966] Clear User Report Codes

Option

OFF

ON

[2] Clear user report codes*

Disabled

Enabled

* Ensure all other options are deselected. Press [ENTER] to clear the respective set of report codes before exiting the section.

[967] Reset User Report Codes

Option

OFF

ON

[2] Reset user report codes to default*

Disabled

Enabled





* Ensure all other options are deselected. Press [ENTER] to reset the respective set of report codes before exiting the section.

Section	Arming	Disarming/Cancel Alarm
[471]	S. Master: _/_/_	_/_/_
[472]	Master 1: _/_/_	_/_/_
[473]	Master 2: _/_/_	_/_/_
[474]	User 4: _/_/_	_/_/_
[475]	User 5: _/_/_	_/_/_
[476]	User 6: _/_/_	_/_/_
[477]	User 7: _/_/_	_/_/_
[478]	User 8: _/_/_	_/_/_
[479]	User 9: _/_/_	_/_/_
[480]	User 10: _/_/_	_/_/_
[481]	User 11: _/_/_	_/_/_
[482]	User 12: _/_/_	_/_/_
[483]	User 13: _/_/_	_/_/_
[484]	User 14: _/_/_	_/_/_
[485]	User 15: _/_/_	_/_/_
[486]	User 16: _/_/_	_/_/_

Section	Arming	Disarming/Cancel Alarm
[487]	User 17: _/_/_	_/_/_
[488]	User 18: _/_/_	_/_/_
[489]	User 19: _/_/_	_/_/_
[490]	User 20: _/_/_	_/_/_
[491]	User 21: _/_/_	_/_/_
[492]	User 22: _/_/_	_/_/_
[493]	User 23: _/_/_	_/_/_
[494]	User 24: _/_/_	_/_/_
[495]	User 25: _/_/_	_/_/_
[496]	User 26: _/_/_	_/_/_
[497]	User 27: _/_/_	_/_/_
[498]	User 28: _/_/_	_/_/_
[499]	User 29: _/_/_	_/_/_
[500]	User 30: _/_/_	_/_/_
[501]	User 31: _/_/_	_/_/_
[502]	User 32: _/_/_	_/_/_

NOTE: For reporting code format instructions, see page 36.

Remote Control Button Assignment

REM1 / REM2 RAC1 / RAC2 REM15				
Default data*:	1	B	C	disabled

* Buttons are programmed using the Button Options Table below.

REM3	PGM1 [9]	PGM2 [0]	PGM3 [x]	PGM4 [P]	PGM5 [●]	PGM6 [●]	PGM3&4 [x] + [✓]	PGM5&6 [●] + [●]
Default data*:	B	C	D	E	5	6	disabled	disabled

[610]	All RCs	_____	_____	_____	_____	_____	_____	_____
	RC#	IMPORTANT: When section [610] is accessed, the panel will copy the saved value of that section to all remotes.						
[611]	1	_____	_____	_____	_____	_____	_____	_____
[612]	2	_____	_____	_____	_____	_____	_____	_____
[613]	3	_____	_____	_____	_____	_____	_____	_____
[614]	4	_____	_____	_____	_____	_____	_____	_____
[615]	5	_____	_____	_____	_____	_____	_____	_____
[616]	6	_____	_____	_____	_____	_____	_____	_____
[617]	7	_____	_____	_____	_____	_____	_____	_____
[618]	8	_____	_____	_____	_____	_____	_____	_____
[619]	9	_____	_____	_____	_____	_____	_____	_____
[620]	10	_____	_____	_____	_____	_____	_____	_____
[621]	11	_____	_____	_____	_____	_____	_____	_____
[622]	12	_____	_____	_____	_____	_____	_____	_____
[623]	13	_____	_____	_____	_____	_____	_____	_____
[624]	14	_____	_____	_____	_____	_____	_____	_____
[625]	15	_____	_____	_____	_____	_____	_____	_____
[626]	16	_____	_____	_____	_____	_____	_____	_____
[627]	17	_____	_____	_____	_____	_____	_____	_____
[628]	18	_____	_____	_____	_____	_____	_____	_____
[629]	19	_____	_____	_____	_____	_____	_____	_____
[630]	20	_____	_____	_____	_____	_____	_____	_____
[631]	21	_____	_____	_____	_____	_____	_____	_____
[632]	22	_____	_____	_____	_____	_____	_____	_____
[633]	23	_____	_____	_____	_____	_____	_____	_____
[634]	24	_____	_____	_____	_____	_____	_____	_____
[635]	25	_____	_____	_____	_____	_____	_____	_____
[636]	26	_____	_____	_____	_____	_____	_____	_____
[637]	27	_____	_____	_____	_____	_____	_____	_____
[638]	28	_____	_____	_____	_____	_____	_____	_____
[639]	29	_____	_____	_____	_____	_____	_____	_____
[640]	30	_____	_____	_____	_____	_____	_____	_____
[641]	31	_____	_____	_____	_____	_____	_____	_____
[642]	32	_____	_____	_____	_____	_____	_____	_____

Button Options Table (refer to Decimal and Hexadecimal Values on page 6)	
[SLEEP] - Empty / Button disabled	[A] - Panic 3
[1] - Regular / Regular Force arming	[B] - PGM Activation (Event Group #8)*
[2] - Stay / Stay Force arming	[C] - PGM Activation (Event Group #9)*
[3] - N/A	[D] - PGM Activation (Event Group #10)*
[4] - Sleep / Sleep Force arming	[E] - PGM Activation (Event Group #11)*
[5] - PGM Activation (Event Group 22)*	[F] - Paramedic alarm
[6] - PGM Activation (Event Group 23)*	
[7] - Activate window mode (StayD)	
[8] - Panic 1	
[9] - Panic 2	
	* See PGM Programming on page 29.

NOTE: The disarm button () cannot be modified.

Remote Controls Supported:
REM1 / REM2
RAC1 / RAC2
REM3 / REM15

[701] REM2 Version Number**Option**

[6] REM2 version number

OFF REM2 V2.00**ON** REM2 V2.01 or higher**[704] Arming/Disarming Options****Option**

[4] Bell squawk when arm/disarm with remote

OFF Disabled**ON** Enabled

[8] No exit delay when arm with a remote

 Disabled Enabled

Remote Control (RC) User Assignment

To assign a remote:

While in the respective section, press a button on the designated remote.

To delete a remote control:

Enter [000000] in its respective section.

To view the serial number of a remote:

Refer to section [960] on page 6.

Section	Section	Section	Section
[651] RC 1 for User 1	[659] RC 9 for User 9	[667] RC 17 for User 17	[675] RC 25 for User 25
[652] RC 2 for User 2	[660] RC 10 for User 10	[668] RC 18 for User 18	[676] RC 26 for User 26
[653] RC 3 for User 3	[661] RC 11 for User 11	[669] RC 19 for User 19	[677] RC 27 for User 27
[654] RC 4 for User 4	[662] RC 12 for User 12	[670] RC 20 for User 20	[678] RC 28 for User 28
[655] RC 5 for User 5	[663] RC 13 for User 13	[671] RC 21 for User 21	[679] RC 29 for User 29
[656] RC 6 for User 6	[664] RC 14 for User 14	[672] RC 22 for User 22	[680] RC 30 for User 30
[657] RC 7 for User 7	[665] RC 15 for User 15	[673] RC 23 for User 23	[681] RC 31 for User 31
[658] RC 8 for User 8	[666] RC 16 for User 16	[674] RC 24 for User 24	[682] RC 32 for User 32

Refer to the **Master Quick Menu** in the User Guide for user code/remote control programming.

Code Entry for Action Keys (REM3)

The six action keys (PGM1 to PGM6) and disarm keys (OFF) can be programmed to require a code entry for use.

NOTE: The [ARM], [SLP] and [STAY] button follow the keypad section [703] options [1], [2], and [3].

Section	OFF	ON
[360] [1] All odd-numbered REM3s [2] All odd-numbered REM3s [3] & [4] [5] All even-numbered REM3s [6] All even-numbered REM3s	<input type="checkbox"/> = Code entry for PGM <input type="checkbox"/> = Code entry disarm N/A <input type="checkbox"/> = Code entry for PGM <input type="checkbox"/> = Code entry disarm	<input type="checkbox"/> = One-touch PGM <input type="checkbox"/> = One-touch disarm N/A <input type="checkbox"/> = One-touch PGM <input type="checkbox"/> = One-touch disarm
[361] [1] REM3 #1 [2] REM3 #1 [3] & [4] [5] REM3 #2 [6] REM3 #2	<input type="checkbox"/> = Code entry for PGM <input type="checkbox"/> = Code entry disarm N/A <input type="checkbox"/> = Code entry for PGM <input type="checkbox"/> = Code entry disarm	<input type="checkbox"/> = One-touch PGM <input type="checkbox"/> = One-touch disarm N/A <input type="checkbox"/> = One-touch PGM <input type="checkbox"/> = One-touch disarm
[362] [1] REM3 #3 [2] REM3 #3 [3] & [4] [5] REM3 #4 [6] REM3 #4	<input type="checkbox"/> = Code entry for PGM <input type="checkbox"/> = Code entry disarm N/A <input type="checkbox"/> = Code entry for PGM <input type="checkbox"/> = Code entry disarm	<input type="checkbox"/> = One-touch PGM <input type="checkbox"/> = One-touch disarm N/A <input type="checkbox"/> = One-touch PGM <input type="checkbox"/> = One-touch disarm
[363] [1] REM3 #5 [2] REM3 #5 [3] & [4] [5] REM3 #6 [6] REM3 #6	<input type="checkbox"/> = Code entry for PGM <input type="checkbox"/> = Code entry disarm N/A <input type="checkbox"/> = Code entry for PGM <input type="checkbox"/> = Code entry disarm	<input type="checkbox"/> = One-touch PGM <input type="checkbox"/> = One-touch disarm N/A <input type="checkbox"/> = One-touch PGM <input type="checkbox"/> = One-touch disarm
[364] [1] REM3 #7 [2] REM3 #7 [3] & [4] [5] REM3 #8 [6] REM3 #8	<input type="checkbox"/> = Code entry <input type="checkbox"/> = Code entry disarm N/A <input type="checkbox"/> = Code entry for PGM <input type="checkbox"/> = Code entry disarm	<input type="checkbox"/> = One-touch PGM <input type="checkbox"/> = One-touch disarm N/A <input type="checkbox"/> = One-touch PGM <input type="checkbox"/> = One-touch disarm

Section		OFF	ON
[365]	[1] REM3 #9	<input type="checkbox"/> = Code entry for PGM	<input type="checkbox"/> = One-touch PGM
	[2] REM3 #9	<input type="checkbox"/> = Code entry disarm	<input type="checkbox"/> = One-touch disarm
	[3] & [4]	N/A	N/A
	[5] REM3 #10	<input type="checkbox"/> = Code entry for PGM	<input type="checkbox"/> = One-touch PGM
	[6] REM3 #10	<input type="checkbox"/> = Code entry disarm	<input type="checkbox"/> = One-touch disarm
	[366]	[1] REM3 #11	<input type="checkbox"/> = Code entry for PGM
[2] REM3 #11		<input type="checkbox"/> = Code entry disarm	<input type="checkbox"/> = One-touch disarm
[3] & [4]		N/A	N/A
[5] REM3 #12		<input type="checkbox"/> = Code entry for PGM	<input type="checkbox"/> = One-touch PGM
[6] REM3 #12		<input type="checkbox"/> = Code entry disarm	<input type="checkbox"/> = One-touch disarm
[367]		[1] REM3 #13	<input type="checkbox"/> = Code entry for PGM
	[2] REM3 #13	<input type="checkbox"/> = Code entry disarm	<input type="checkbox"/> = One-touch disarm
	[3] & [4]	N/A	N/A
	[5] REM3 #14	<input type="checkbox"/> = Code entry for PGM	<input type="checkbox"/> = One-touch PGM
	[6] REM3 #14	<input type="checkbox"/> = Code entry disarm	<input type="checkbox"/> = One-touch disarm
	[368]	[1] REM3 #15	<input type="checkbox"/> = Code entry for PGM
[2] REM3 #15		<input type="checkbox"/> = Code entry disarm	<input type="checkbox"/> = One-touch disarm
[3] & [4]		N/A	N/A
[5] REM3 #16		<input type="checkbox"/> = Code entry for PGM	<input type="checkbox"/> = One-touch PGM
[6] REM3 #16		<input type="checkbox"/> = Code entry disarm	<input type="checkbox"/> = One-touch disarm
[369]		[1] REM3 #17	<input type="checkbox"/> = Code entry for PGM
	[2] REM3 #17	<input type="checkbox"/> = Code entry disarm	<input type="checkbox"/> = One-touch disarm
	[3] & [4]	N/A	N/A
	[5] REM3 #18	<input type="checkbox"/> = Code entry for PGM	<input type="checkbox"/> = One-touch PGM
	[6] REM3 #18	<input type="checkbox"/> = Code entry disarm	<input type="checkbox"/> = One-touch disarm
	[370]	[1] REM3 #19	<input type="checkbox"/> = Code entry for PGM
[2] REM3 #19		<input type="checkbox"/> = Code entry disarm	<input type="checkbox"/> = One-touch disarm
[3] & [4]		N/A	N/A
[5] REM3 #20		<input type="checkbox"/> = Code entry for PGM	<input type="checkbox"/> = One-touch PGM
[6] REM3 #20		<input type="checkbox"/> = Code entry disarm	<input type="checkbox"/> = One-touch disarm
[371]		[1] REM3 #21	<input type="checkbox"/> = Code entry for PGM
	[2] REM3 #21	<input type="checkbox"/> = Code entry disarm	<input type="checkbox"/> = One-touch disarm
	[3] & [4]	N/A	N/A
	[5] REM3 #22	<input type="checkbox"/> = Code entry for PGM	<input type="checkbox"/> = One-touch PGM
	[6] REM3 #22	<input type="checkbox"/> = Code entry disarm	<input type="checkbox"/> = One-touch disarm
	[372]	[1] REM3 #23	<input type="checkbox"/> = Code entry for PGM
[2] REM3 #23		<input type="checkbox"/> = Code entry disarm	<input type="checkbox"/> = One-touch disarm
[3] & [4]		N/A	N/A
[5] REM3 #24		<input type="checkbox"/> = Code entry for PGM	<input type="checkbox"/> = One-touch PGM
[6] REM3 #24		<input type="checkbox"/> = Code entry disarm	<input type="checkbox"/> = One-touch disarm
[373]		[1] REM3 #25	<input type="checkbox"/> = Code entry for PGM
	[2] REM3 #25	<input type="checkbox"/> = Code entry disarm	<input type="checkbox"/> = One-touch disarm
	[3] & [4]	N/A	N/A
	[5] REM3 #26	<input type="checkbox"/> = Code entry for PGM	<input type="checkbox"/> = One-touch PGM
	[6] REM3 #26	<input type="checkbox"/> = Code entry disarm	<input type="checkbox"/> = One-touch disarm
	[374]	[1] REM3 #27	<input type="checkbox"/> = Code entry for PGM
[2] REM3 #27		<input type="checkbox"/> = Code entry disarm	<input type="checkbox"/> = One-touch disarm
[3] & [4]		N/A	N/A
[5] REM3 #28		<input type="checkbox"/> = Code entry for PGM	<input type="checkbox"/> = One-touch PGM
[6] REM3 #28		<input type="checkbox"/> = Code entry disarm	<input type="checkbox"/> = One-touch disarm
[375]		[1] REM3 #29	<input type="checkbox"/> = Code entry for PGM
	[2] REM3 #29	<input type="checkbox"/> = Code entry disarm	<input type="checkbox"/> = One-touch disarm
	[3] & [4]	N/A	N/A
	[5] REM3 #30	<input type="checkbox"/> = Code entry for PGM	<input type="checkbox"/> = One-touch PGM
	[6] REM3 #30	<input type="checkbox"/> = Code entry disarm	<input type="checkbox"/> = One-touch disarm
	[376]	[1] REM3 #31	<input type="checkbox"/> = Code entry for PGM
[2] REM3 #31		<input type="checkbox"/> = Code entry disarm	<input type="checkbox"/> = One-touch disarm
[3] & [4]		N/A	N/A
[5] REM3 #32		<input type="checkbox"/> = Code entry for PGM	<input type="checkbox"/> = One-touch PGM
[6] REM3 #32		<input type="checkbox"/> = Code entry disarm	<input type="checkbox"/> = One-touch disarm

Hardware Connections

Single Zone Inputs

N.C. Contacts, No EOL

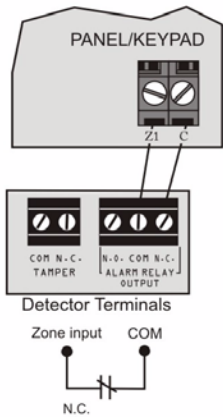

N.C., With EOL
UL/ULC Configuration

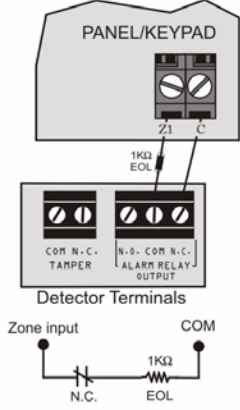

N.O., With EOL
UL/ULC Configuration

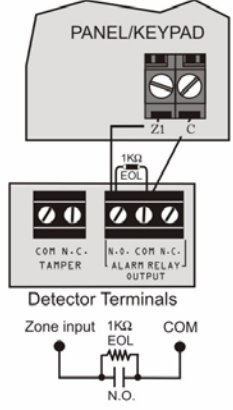

N.C. Contacts, No EOL,
With Tamper Recognition

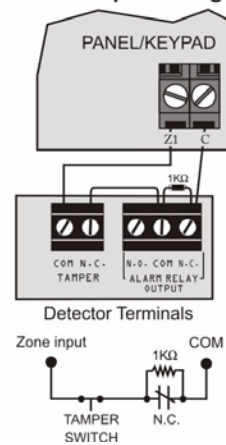

N.C., With EOL, With
Tamper & Wire Fault
Recognition (UL/ULC)

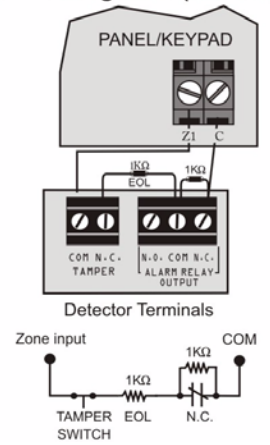

NOTE: Keyswitches are connected as standard zones and will follow ATZ options programmed in section [705] options [1] and [2] on page 16.

Advanced Technology Zone (ATZ) Connections

N.C. Contacts, No EOL

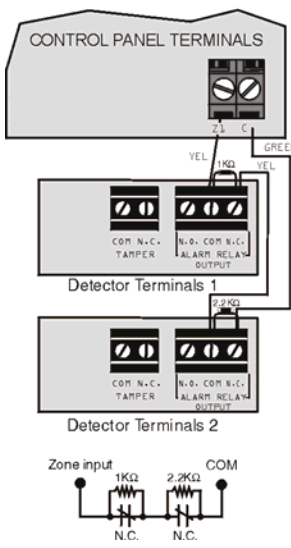

N.C. Contacts, No EOL, with Tamper Recognition

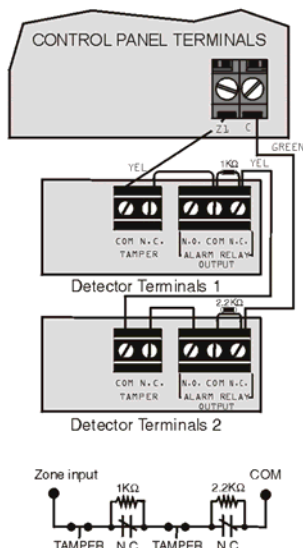

N.C. Contacts, with EOL, with Tamper
and Wire Fault Recognition (UL/cUL)

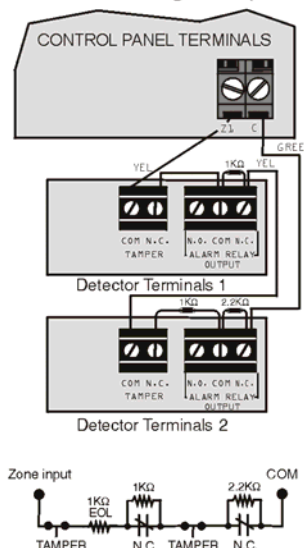

Parallel Wiring

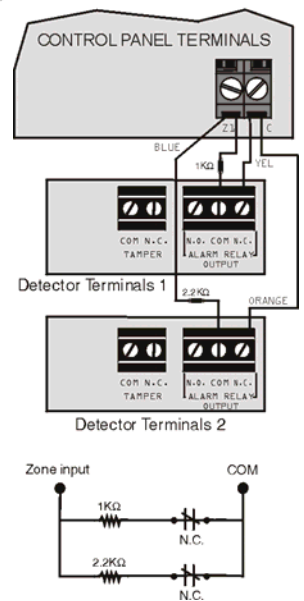

Connecting Fire Circuits

NOTE: For 4-wire installation: Program the Activation Event so that the smoke detectors can be reset by pressing the [CLEAR] + [ENTER] keys for three seconds. See Event Group # 6 on page 30. For 2-wire installation (except SP5500): Press [CLEAR] + [ENTER] to automatically reset smoke.

Fire Circuits 4-WIRE INSTALLATION CONTROL PANEL TERMINALS

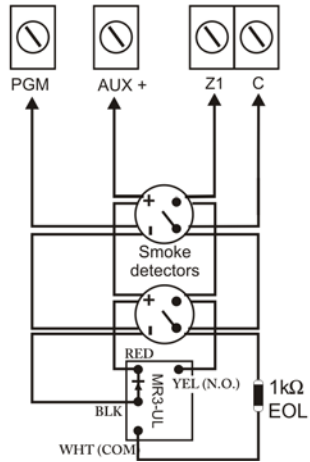

2-WIRE INSTALLATION CONTROL PANEL TERMINALS

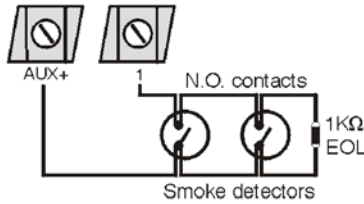

WARNING: It is recommended that the smoke detectors be connected in a daisy chain configuration. Each control panel (except the SP5500) supports a maximum of five 2-wire smoke detectors.

Alarm Relay and PGM Connections

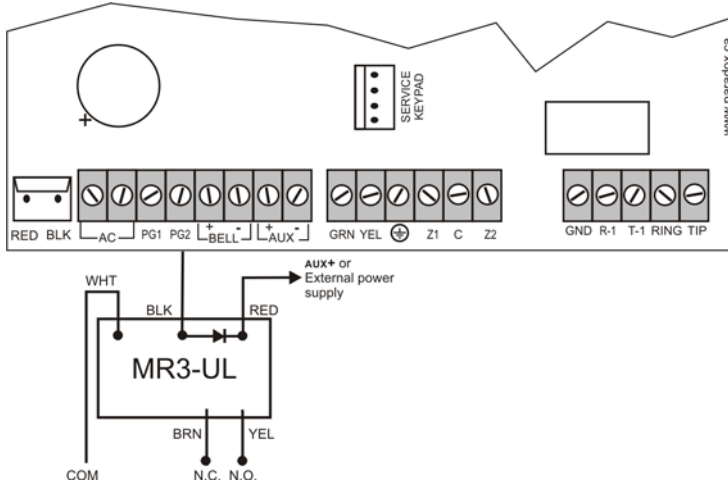

PGM Power Source

AUX + terminal	= must not exceed 700mA.
External power supply = PGM1 and PGM2	cannot exceed 100mA or cannot exceed the power supply's current limit.

AC Power & Backup Battery Connections

Transformer Requirements

Transformer:	16VAC 20VA* (Amseco XP-1620) 16.5VAC 40VA (Universal UB1640W) *not verified by UL
DC Power Supply rated at:	MG5000/MG5050 = 1.0A SP5500/SP6000/SP7000 = 1.4A
Auxiliary Supply can provide a maximum of:	typ: 600mA max: 700mA UL installations: typ. 200mA
Acceptable Battery Charge Currents (section [700] option [2])	350mA/700mA

Rechargeable Battery
UL/ULC - 12Vdc / 4Ah or 7Ah

Partial view of control panel

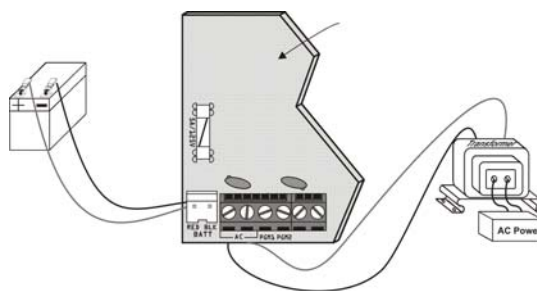

UL Warning: A 12Vdc / 7Ah battery is required to comply with UL fire requirements.

WARNING: Improper connection of the transformer may result in damage to the system.

WARNING: Disconnect battery before replacing the fuse.

Connecting to WinLoad / BabyWare

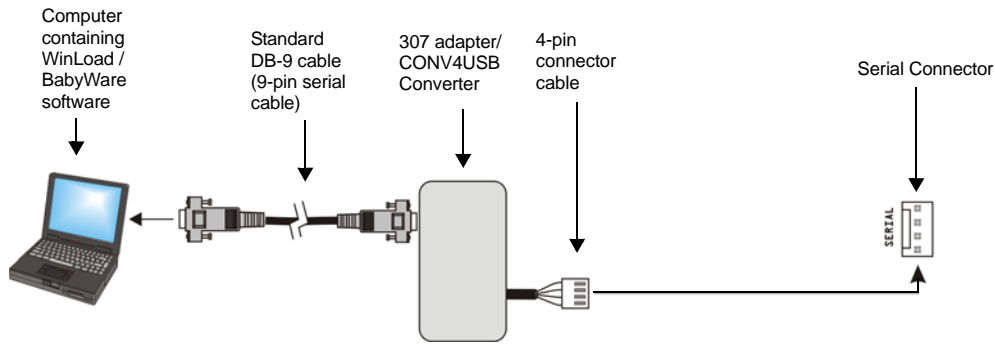

Updating Firmware Using WinLoad / BabyWare

To update your system firmware:

1. Connect the product to your computer using a 307USB Direct Connect Interface or CV4USB Converter.
2. Start WinLoad / BabyWare Installer Upload/Download Software.
3. Click the **In-Field Programmer button**. 
4. Verify the product information located in the In-Field Firmware Programmer window.
If the firmware programmer does not automatically detect your control panel, click the **Com port settings** button and select the correct Com port. Then click the **Refresh Product Info** button to connect with the panel.
5. To check for new updates, click the **Download Firmware from the web** button.
6. From the Select Firmware drop-down box, select the firmware version you wish to install.
or
If you have already downloaded the .pef/.puf file from paradox.com, click the [...] button and select the location of the .pef/.puf file.
7. Click the **Update product firmware** button.
8. When the download process finishes, the update is complete.

Metal Box Installation

Use the numbered holes in the following diagram to identify the correct mounting location for the control panel being installed. If you require specific dimensions, contact Paradox Distributor Support.

Identify the correct mounting holes according to the following table:

Product	8x10" Metal Box Holes	11x11" Metal Box Holes
MG5000*	3, 6, 9, 11, 14	6, 8, 12, 18, 20
MG5050	11x11" box only	1, 4, 11, 19, 22
SP4000	5, 7, 13, 16	7, 19, 20
SP5500	1, 2, 17, 18	1, 2, 11, 19, 21
SP6000	1, 2, 17, 18	1, 2, 11, 19, 21
SP7000	11x11" box only	1, 4, 11, 19, 22

* For UL recommended installation for the MG5000 only, place the PCB one notch lower than the mounting location.

Example: Install an MG5000 in an 8x10" box as follows:

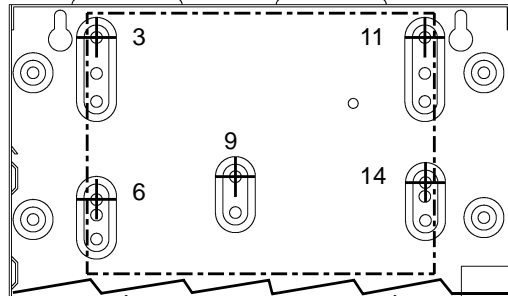

8x10" Metal Box

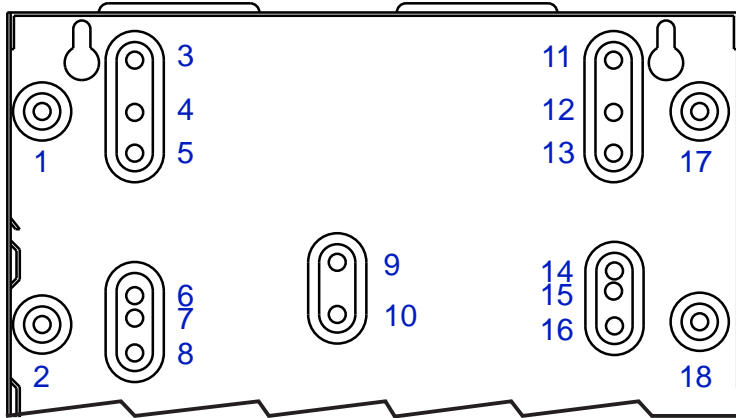

11x11" Metal Box

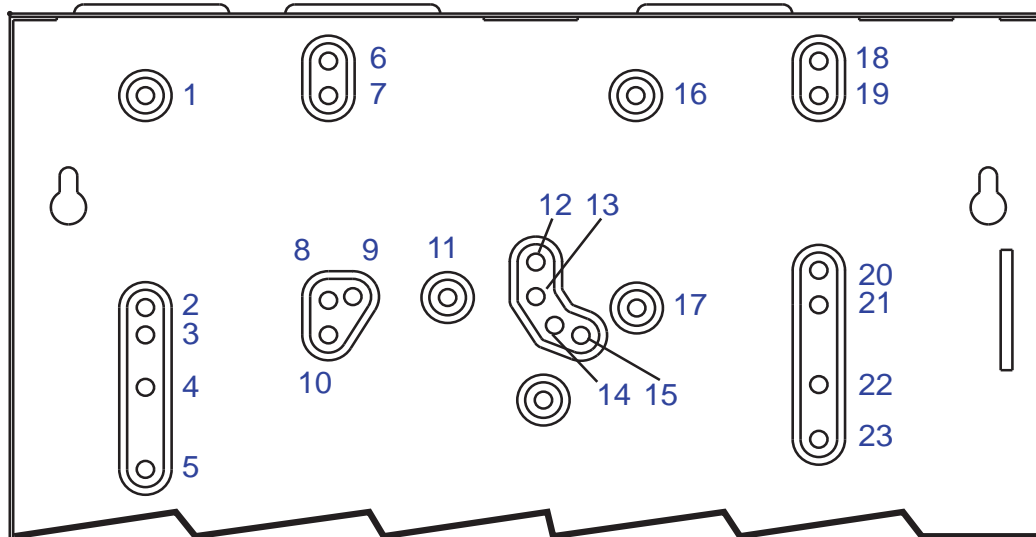

MG5000 PCB Layout

Used for In-Field Firmware upgrade through a 307USB Direct Connect Interface. See Connecting to WinLoad on page 57 for details.

EBUS and Dialer used with: VDMP3 plug-in voice module for voice reporting PCS Series GSM communicator module

Press and hold the RESET button for five seconds. The STATUS LED will start flashing. Within 2 seconds of this flashing, press the reset switch again. The panel will reset to default and restart.

Four pin connector can be used for quick installation of a keypad.



Refer to AC Power & Backup Battery Connections on page 56.

The "BELL" output will shutdown if the current exceeds 3A.

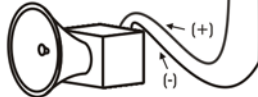

Connection for Self-Contained Bell/Siren

Warning: The sum of the current drawn from the BELL and AUX must be limited to 1.3A (40VA transformer strongly recommended). Exceeding this limit will overload the panel power supply and lead to complete system shutdown.

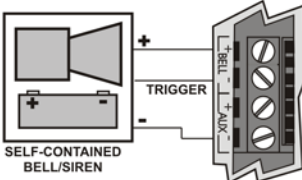

AUX Power

Refer to transformer requirements on page 56 for Aux. Power Output. To connect additional wiring to auxiliary power, use the red (+) and black (-) keypad connectors. Auxiliary power will shut down if current exceeds 1.1A. If the auxiliary output is overloaded and is shut down, you must disconnect all loads from the output for at least 10 seconds before reconnecting any load back to the auxiliary output.

Warning: This equipment must be installed and maintained by qualified service personnel only. For UL and C-UL warnings, refer to the UL and C-UL Warnings section at the back of the Reference & Installation Manual.

Charge LED:

Charging and Battery test LED

"STATUS" LED:

Flash once every second = Normal
Flashes ON 1 second and OFF 1 second = Any trouble
Always ON = Panel is using phone line
Fast flash 6 seconds after power up = Installer lock enabled

"RX" & "TX" LED:

Flashes quickly when receiving or transmitting RF signals from wireless devices.

Warning: Do not cut, bend or alter the antennas and ensure that electrical wires do not cross over the antennae, as this may affect signal reception.

Warning: Disconnect telephone line before servicing.

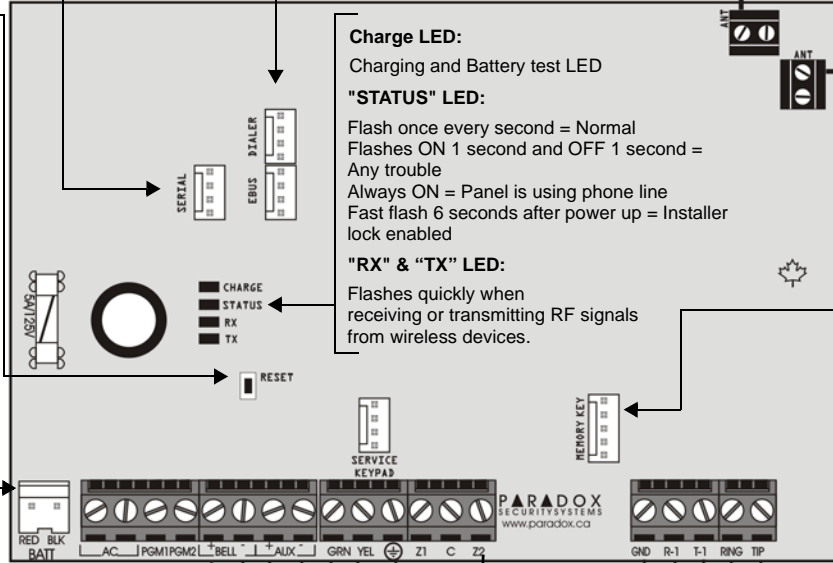

Refer to Single Zone Inputs on page 55

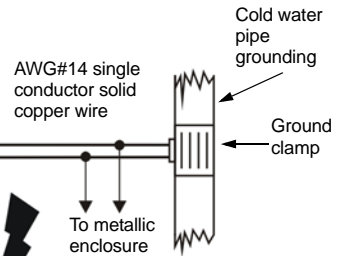

Warning: To provide maximum lightning protection we strongly recommend having separate earth connections for the dialer and zone ground terminals.

Warning: Max. number of keypads = 15 keypads
Max. aux. current = 700 mA
Max. distance of bus module from panel = 76m (250 feet)
Max. total run of wire = 230m (750 feet)

* If EOL is enabled: see section [706] option [2]. For the keypad's zone configurations, refer to Installer Quick Menu on page 65. Also refer to keypad zone connections on page 55.

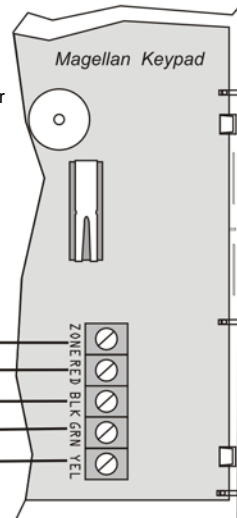

For the keypad's zone configurations, refer to the Installer Quick Menu. If EOL is enabled: see section [706] option [2]. Also refer to Keypad Zone Connections on page 55.

MG5050 PCB Layout

LEDs

Charge LED:
Charging and battery test LED

Status LED:

- Flash once every second = Normal
- Flashes ON 1 second and OFF 1 second = Any trouble
- Always ON = Panel is using phone line
- Fast flash 6 seconds after power up = Installer lock enabled

"RX" & "TX" LED:
Flashes quickly when receiving or transmitting RF signals from wireless devices.

SERVICE KEYPAD

Four pin connector can be used for quick installation of a keypad.

Refer to *AC Power & Backup Battery Connections* on page 56.

The "BELL" output will shutdown if the current exceeds 3A.

Connection for Self-Contained Bell/Siren

Warning: The sum of the current drawn from the BELL and AUX must be limited to 1.3A (40VA transformer strongly recommended). Exceeding this limit will overload the panel power supply and lead to complete system shutdown.

AUX Power

Refer to transformer requirements on page 56 for Aux. Power Output. To connect additional wiring to auxiliary power, use the red (+) and black (-) keypad connectors. Auxiliary power will shut down if current exceeds 1.1A. If the auxiliary output is overloaded and is shut down, you must disconnect all loads from the output for at least 10 seconds before reconnecting any load back to the auxiliary output.

Warning: This equipment must be installed and maintained by qualified service personnel only. For UL and C-UL warnings, refer to the UL and C-UL Warnings section at the back of the Reference & Installation Manual.

Warning: Do not cut, bend or alter the antennas and ensure that electrical wires do not cross over the antennae, as this may affect signal reception.

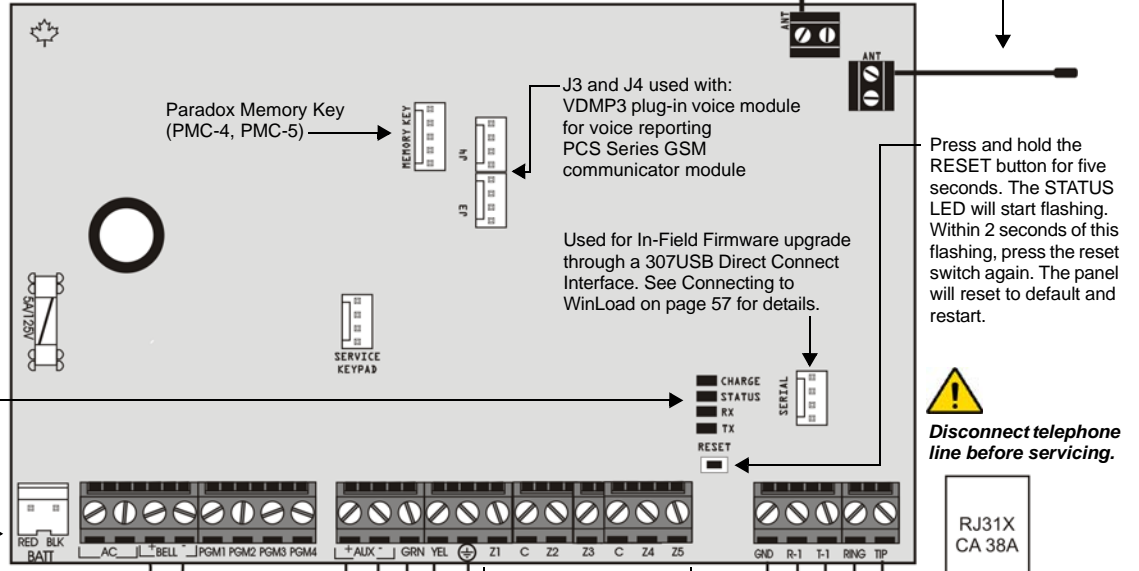

Refer to Single Zone Inputs on page 55.

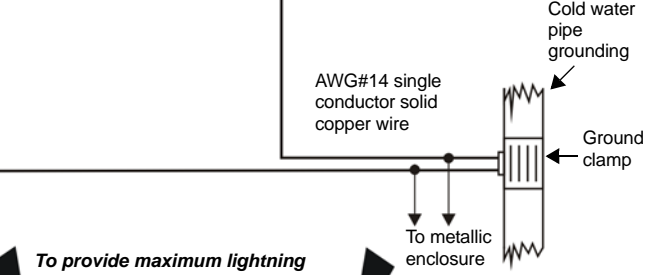

Warning: To provide maximum lightning protection we strongly recommend having separate earth connections for the dialer and zone ground terminals.

Warning:

- Max. number of keypads = 15 keypads
- Max. aux. current = 700 mA
- Max. distance of bus module from panel = 76m (250 feet)
- Max. total run of wire = 230m (750 feet)

* If EOL is enabled: see section [706] option [2]. For the keypad's zone configurations, refer to Installer Quick Menu on page 65. Also refer to keypad zone connections on page 55.

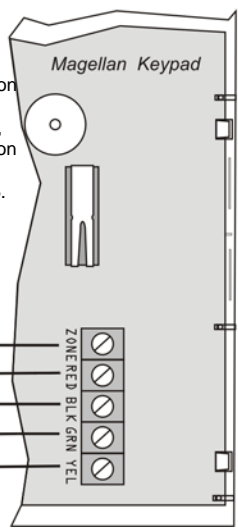

For the keypad's zone configurations, refer to the **Installer Quick Menu**. If EOL is enabled: see section [706] option [2]. Also refer to Keypad Zone Connections on page 55.

SP4000 PCB Layout

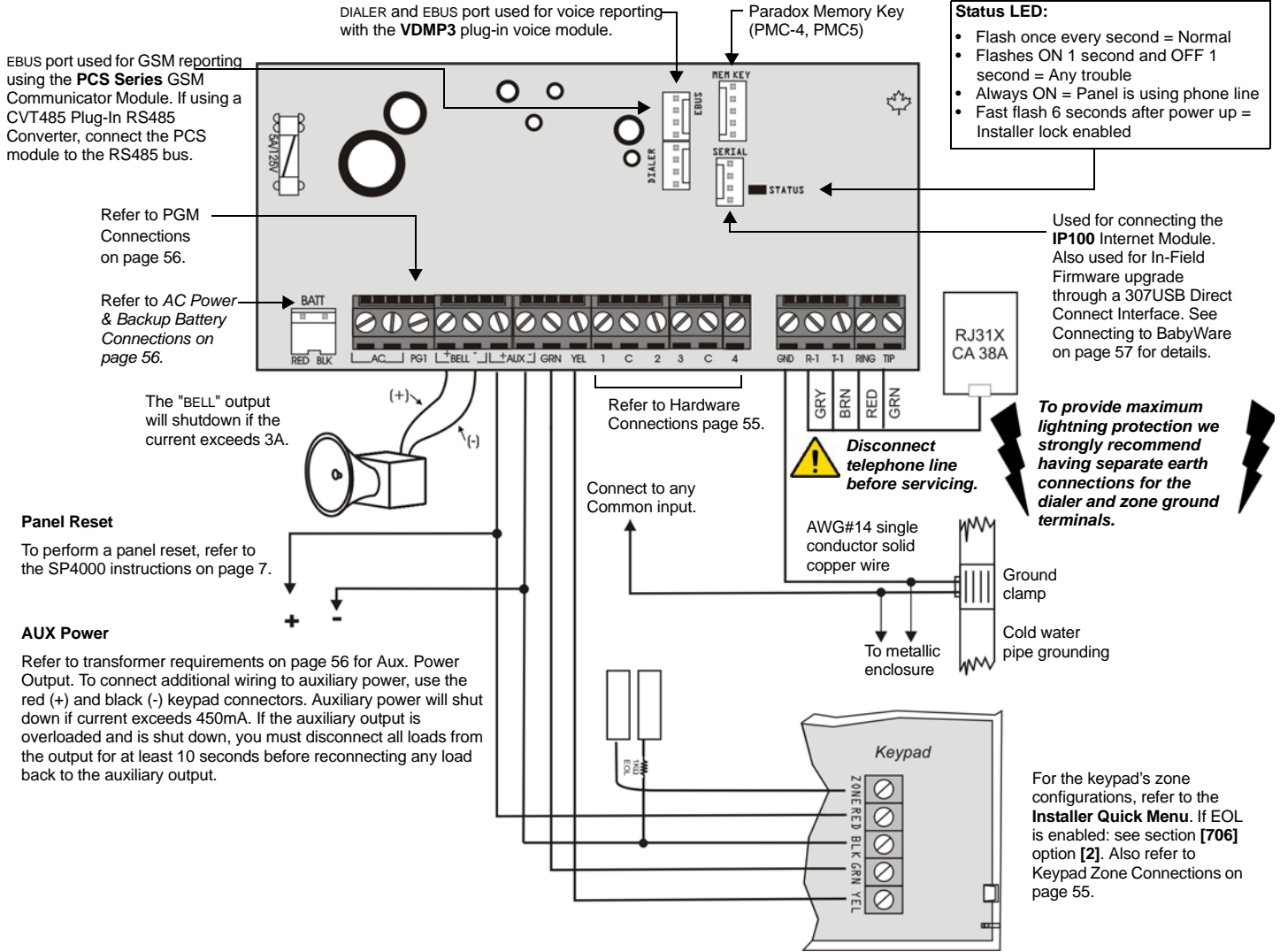

40VA transformer strongly recommended

This equipment must be installed and maintained by qualified service personnel only. For UL and C-UL warnings, refer to the UL and C-UL Warnings section at the back of the SP4000 Reference & Installation Manual.

Max. number of keypads = 15 keypads

Max. aux. current = 650 mA

Max. distance of keypad from panel = 76m (250 feet)

Max. total run of wire = 230m (750 feet)

SP5500 PCB Layout

Charge LED:
Charging and battery test LED

Status LED:

- Flash once every second = Normal
- Flashes ON 1 second and OFF 1 second = Any trouble
- Always ON = Panel is using phone line
- Fast flash 6 seconds after power up = Installer lock enabled

Used for In-Field Firmware upgrade through a 307USB Direct Connect Interface. See Connecting to WinLoad on page 57 for details.

Four pin connector can be used for quick installation of a SP5500 keypad.

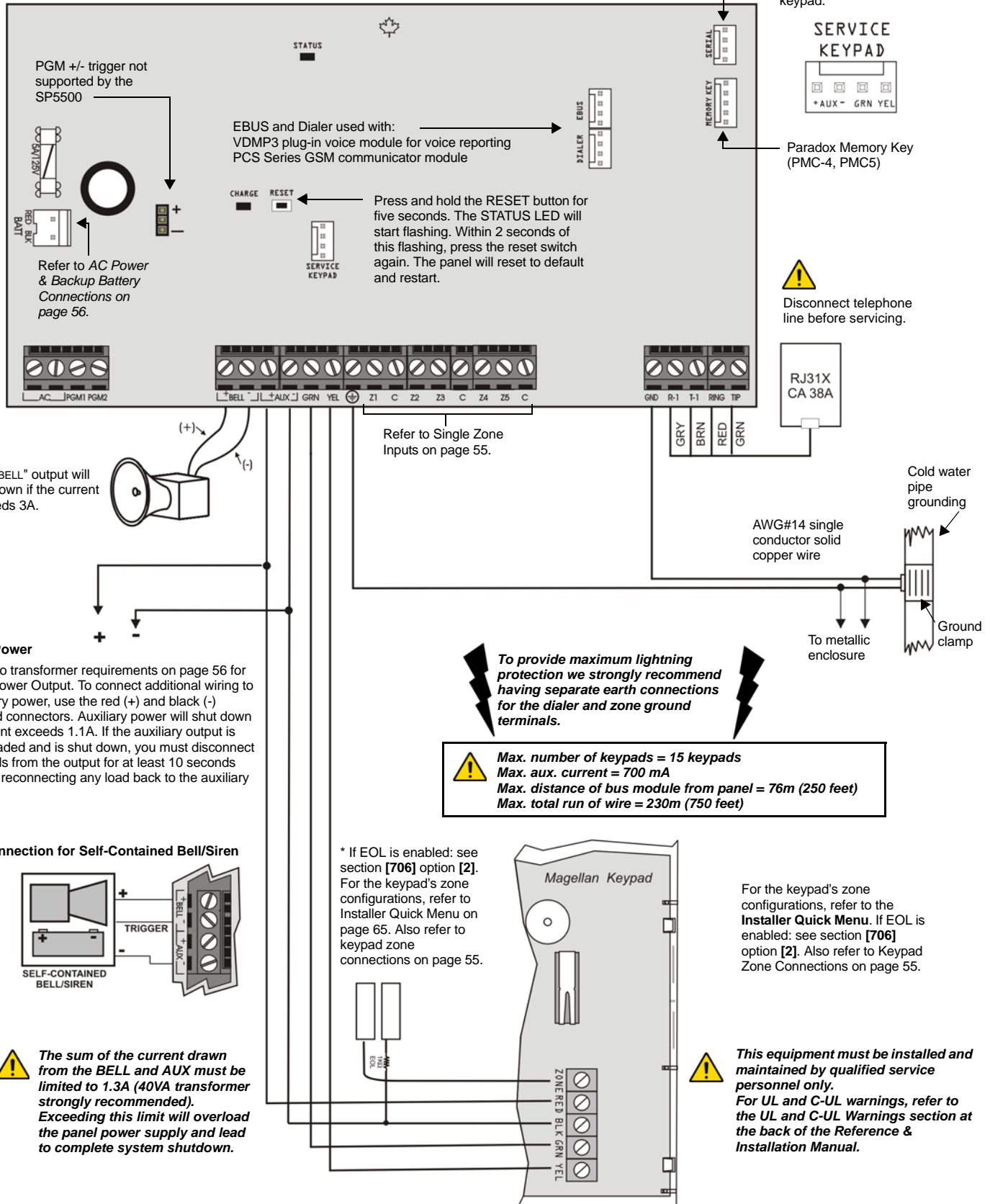

PGM +/- trigger not supported by the SP5500

Refer to AC Power & Backup Battery Connections on page 56.

EBUS and Dialer used with: VDMP3 plug-in voice module for voice reporting PCS Series GSM communicator module

Press and hold the RESET button for five seconds. The STATUS LED will start flashing. Within 2 seconds of this flashing, press the reset switch again. The panel will reset to default and restart.

SERVICE KEYPAD



Paradox Memory Key (PMC-4, PMC5)

Disconnect telephone line before servicing.



The "BELL" output will shutdown if the current exceeds 3A.



Refer to Single Zone Inputs on page 55.

AUX Power

Refer to transformer requirements on page 56 for Aux. Power Output. To connect additional wiring to auxiliary power, use the red (+) and black (-) keypad connectors. Auxiliary power will shut down if current exceeds 1.1A. If the auxiliary output is overloaded and is shut down, you must disconnect all loads from the output for at least 10 seconds before reconnecting any load back to the auxiliary output.

Connection for Self-Contained Bell/Siren

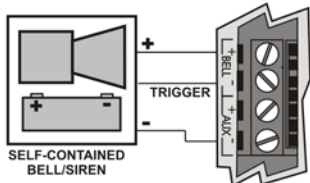

Warning: The sum of the current drawn from the BELL and AUX must be limited to 1.3A (40VA transformer strongly recommended). Exceeding this limit will overload the panel power supply and lead to complete system shutdown.

* If EOL is enabled: see section [706] option [2]. For the keypad's zone configurations, refer to Installer Quick Menu on page 65. Also refer to keypad zone connections on page 55.

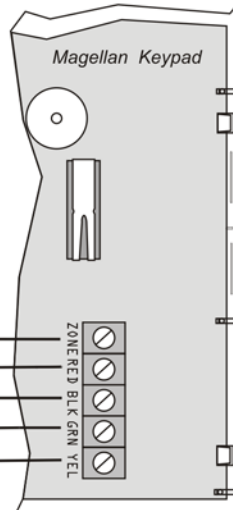

For the keypad's zone configurations, refer to the **Installer Quick Menu**. If EOL is enabled: see section [706] option [2]. Also refer to Keypad Zone Connections on page 55.

Warning: This equipment must be installed and maintained by qualified service personnel only. For UL and C-UL warnings, refer to the UL and C-UL Warnings section at the back of the Reference & Installation Manual.

Warning: To provide maximum lightning protection we strongly recommend having separate earth connections for the dialer and zone ground terminals.

Max. number of keypads = 15 keypads
Max. aux. current = 700 mA
Max. distance of bus module from panel = 76m (250 feet)
Max. total run of wire = 230m (750 feet)

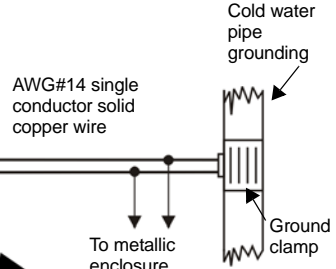

SP6000 PCB Layout

LEDs
 Charge LED:
 Charging and battery test LED

Status LED:

- Flash once every second = Normal
- Flashes ON 1 second and OFF 1 second = Any trouble
- Always ON = Panel is using phone line
- Fast flash 6 seconds after power up = Installer lock enabled

Used for In-Field Firmware upgrade through a 307USB Direct Connect Interface. See Connecting to WinLoad on page 57 for details.

Four pin connector can be used for quick installation of a keypad.

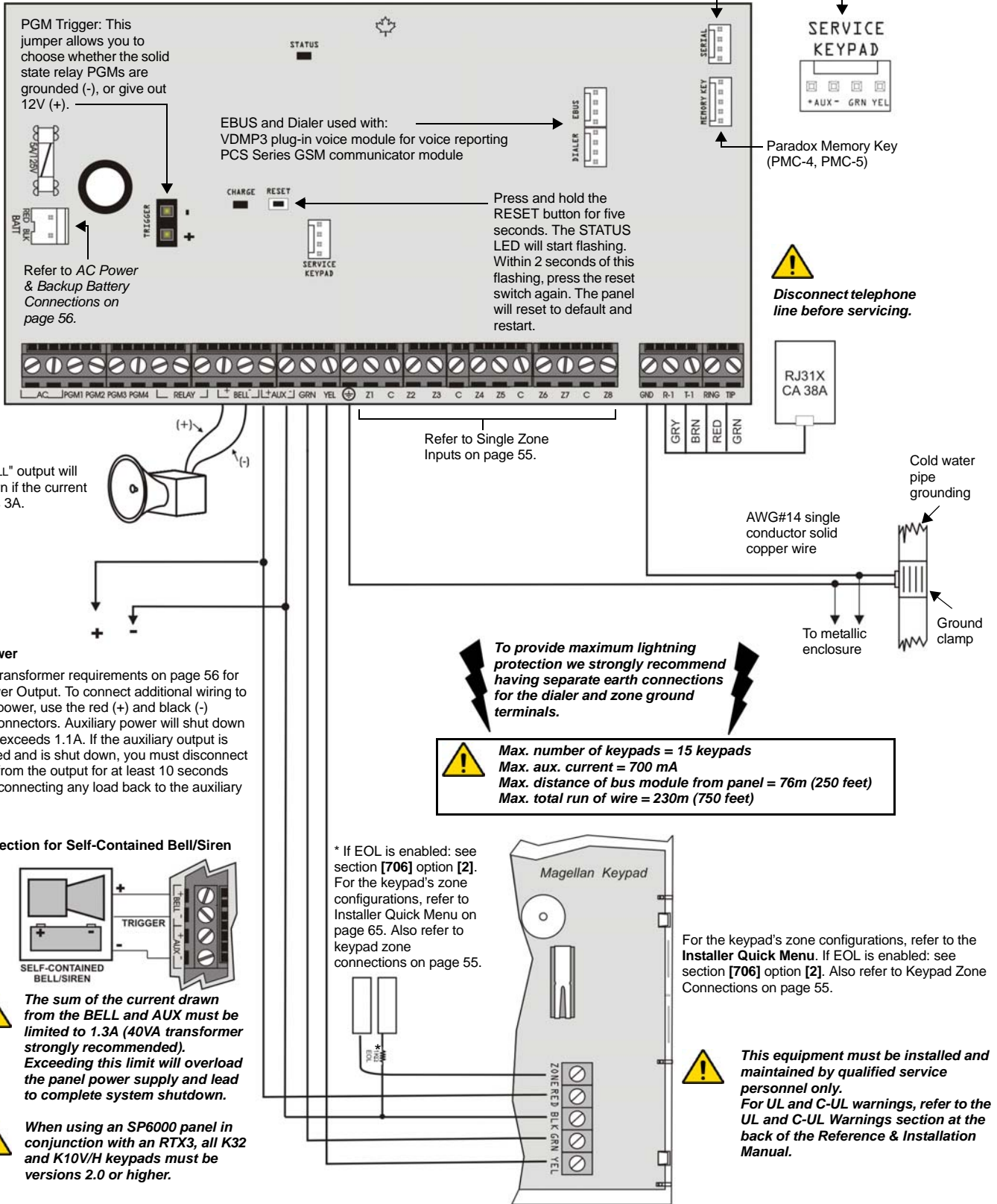

SP7000 PCB Layout

LEDs
 Charge LED:
 Charging and battery test LED

Status LED:

- Flash once every second = Normal
- Flashes ON 1 second and OFF 1 second = Any trouble
- Always ON = Panel is using phone line
- Fast flash 6 seconds after power up = Installer lock enabled

Used for In-Field Firmware upgrade through a 307USB Direct Connect Interface. See Connecting to WinLoad on page 57 for details.

Four pin connector can be used for quick installation of a keypad.

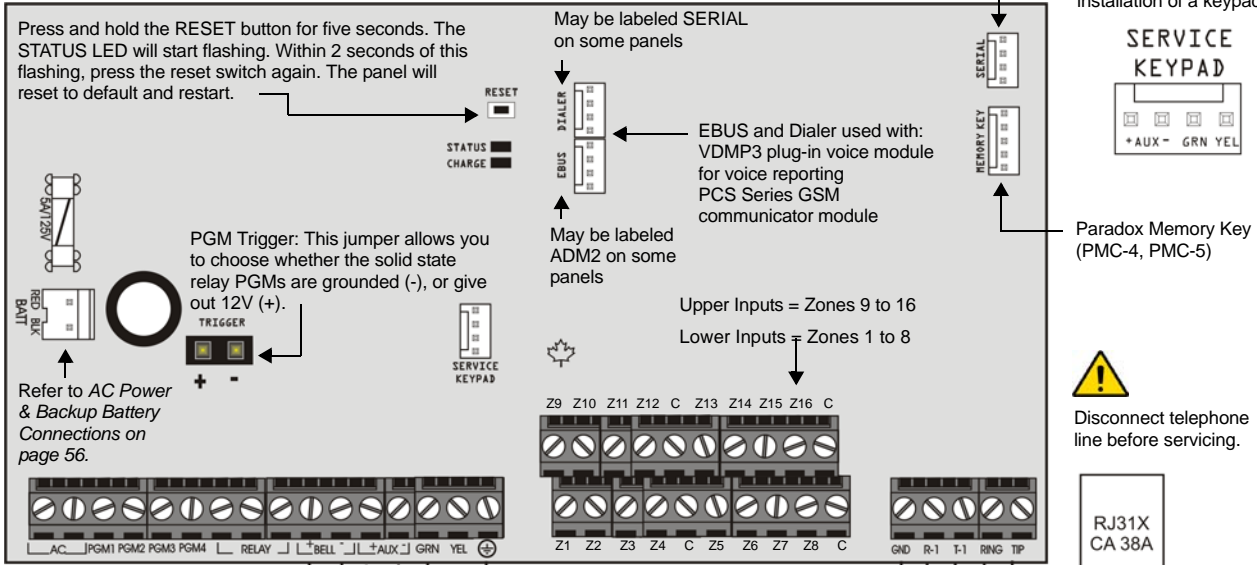

Paradox Memory Key (PMC-4, PMC-5)

The "BELL" output will shutdown if the current exceeds 3A.

AUX Power
 Refer to transformer requirements on page 56 for Aux. Power Output. To connect additional wiring to auxiliary power, use the red (+) and black (-) keypad connectors. Auxiliary power will shut down if current exceeds 1.1A. If the auxiliary output is overloaded and is shut down, you must disconnect all loads from the output for at least 10 seconds before reconnecting any load back to the auxiliary output.

To provide maximum lightning protection we strongly recommend having separate earth connections for the dialer and zone ground terminals.

Max. number of keypads = 15 keypads
Max. aux. current = 700 mA
Max. distance of bus module from panel = 76m (250 feet)
Max. total run of wire = 230m (750 feet)

Connection for Self-Contained Bell/Siren

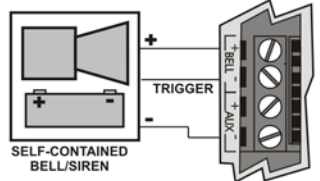

The sum of the current drawn from the BELL and AUX must be limited to 1.3A (40VA transformer strongly recommended). Exceeding this limit will overload the panel power supply and lead to complete system shutdown.

* If EOL is enabled: see section [706] option [2]. For the keypad's zone configurations, refer to Installer Quick Menu on page 65. Also refer to keypad zone connections on page 55.

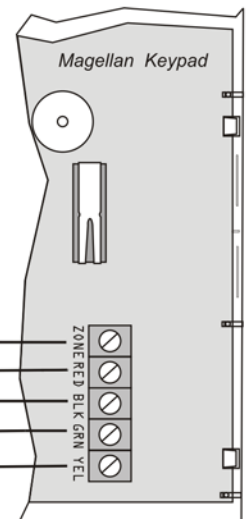

For the keypad's zone configurations, refer to the **Installer Quick Menu**. If EOL is enabled: see section [706] option [2]. Also refer to Keypad Zone Connections on page 55.

This equipment must be installed and maintained by qualified service personnel only.
 For UL and C-UL warnings, refer to the UL and C-UL Warnings section at the back of the Reference & Installation Manual.

Installer Quick Menu

Zones

Step	Action	Details
1	+ [INSTALLER CODE]	= flash. Programmed zones are lit (button or LED depending on keypad). [MAINTENANCE CODE] may also be used.
2	[ZONE NUMBER]	2 digits: 01 to 32
3	[ENROLL OR ERASE ZONE]	Wireless zone = open/close cover or press learn/tamper switch. Hardwired zone = Press [ENTER]. To erase a programmed zone, press [SLEEP] for 3 seconds.
4	[ZONE TYPE]	Refer to page 14 for the zone type (zone definition).
5	Assign Partition [1] and/or [2] + [ENTER]	Assign the zone to one or both partitions and press [ENTER]. By default, all zones are assigned to partition 1. Goes to next available zone.

NOTE: Partition 2 status LEDs, display the signal strength of the selected wireless zone (4 LEDs = best signal; 1 LED = weak signal; No LEDs = hardwired panel/keypad zone)

Keypad Zone Number Assignment (Keypad Programming)

Step	Action	Details
1	[ENTER] + [INSTALLER CODE]	[ARM] + [STAY] = flash. [MAINTENANCE CODE] may also be used.
2	Press and hold (3sec)	[ARM] + [STAY] = on.
3	[ZONE NUMBER] + [ENTER]*	K32 / K32LCD / K35 = 2 digits: 01 to 32 K636 / K10V/H = 1 digit: 1 to 0(10) * To erase a keypad zone number, press [CLEAR], then [ENTER].

Delays

Step	Action	Details
1	+ [INSTALLER CODE]	= flash. [MAINTENANCE CODE] may also be used.
2		
3	[1] = Entry Delay 1 (default = 045 sec.) [2] = Entry Delay 2 (default = 045 sec.) [3] = Exit Delay (default = 060 sec.) [4] = Bell Cut-Off (default = 004 min.)	
4	[000] to [255]	Entry/Exit Delay = seconds / Bell Cut-Off = minutes

Time and Date

Step	Action	Details
1	+ [INSTALLER CODE]	= flash. [MAINTENANCE CODE] may also be used.
2	+ [5]	
4	[HH:MM]	Enter time. If HH = 13 or more, skip to step 6.
5	[TIME FORMAT]	Enter time format ([1] = 24hr; [2] = AM; [3] = PM).
6	[YYYY/MM/DD]	Enter date.

Walk Test Mode

Step	Action	Details
1	+ [INSTALLER CODE]	= flash. [MAINTENANCE CODE] may also be used.
2		
3	[6]	Activates or deactivates Walk Test Mode.

Installer and Maintenance Codes

Step	Action	Details
1	+ [INSTALLER CODE]	= flash.
2		
3	[7] = Installer Code [8] = Maintenance Code	
4	[CODE]*	Enter 4- or 6-digit code.* To erase a code, press the [SLEEP] key for 3 seconds.
5	[CONFIRM CODE]	Re-enter 4- or 6-digit code.

WinLoad / BabyWare

Step	Action	Details
1	+ [INSTALLER CODE]	= flash.
2		
3	[9]	
4	[PHONE #] + [ENTER]*	Enter PC phone # (up to 32 digits) and press [ENTER].* To erase WinLoad / BabyWare phone #, panel ID, and PC password, press the [SLEEP] key for 3 seconds.
5	[PANEL ID]	Enter 4-digit Panel ID
6	[PC PASSWORD]	Enter 4-digit PC Password

Monitoring Phone

Step	Action	Details
1	+ [INSTALLER CODE]	= flash.
2		
3	[1]	
4	[PHONE #] + [ENTER]*	Enter monitoring station phone # (up to 32 digits) and press [ENTER].* To erase monitoring phone #, reporting format, and account #s, press the [SLEEP] key for 3 seconds.
5	[PARTITION 1 ACCOUNT #]	
6	[1] = CID [2] = SIA	NOTE: SIA is not supported with GPRS/IP reporting
7	[PARTITION 2 ACCOUNT #]	









Communicator

Step	Action	Details
1	+ [INSTALLER CODE]	= flash. [MAINTENANCE CODE] may also be used, however, it cannot modify the backup phone number.
2		
3	[2] = Backup Phone # [3] = Personal Phone #1 [4] = Personal Phone #2 [5] = Personal Phone #3 [6] = Personal Phone #4 [7] = Personal Phone #5 [8] = Pager #	
4	[PHONE #] + [ENTER]*	Enter phone # (up to 32 digits) and press [ENTER]. Goes to next phone#, or go to step 5 if [8] = Pager # was selected. To erase a phone number pager message, press the [SLEEP] key for 3 seconds.
5	[MESSAGE] + [ENTER]	Step 5 for Pager # only. Enter pager message and press [ENTER].

Cancel Communication

Step	Action	Details
1	+ [INSTALLER CODE]	= flash. [MAINTENANCE CODE] may also be used.
2		
3	[9]	Cancels all communication with WinLoad / BabyWare / GSM module.

PGMs

Step	Action	Details									
1	 + [INSTALLER CODE]	 = flash. [MAINTENANCE CODE] may also be used.									
2											
3	[PGM NUMBER]	2 digits: 01 to 16									
4	[ENROLL OR ERASE PGM]*	Wireless PGM = Open/close cover. Hardwired PGM = press [ENTER]. To erase a PGM, press the [SLEEP] key for 3 seconds.									
5	[PGM TYPE]	<table border="0"> <tr> <td>1 = Follow Button  or ●</td> <td>5 = Follow Bell</td> </tr> <tr> <td>2 = Follow Button  or ●</td> <td>6 = Follow Arm</td> </tr> <tr> <td>3 = Follow Zone</td> <td>7 = Follow Stay arm</td> </tr> <tr> <td>4 = Follow Alarm</td> <td>8 = Follow Sleep arm</td> </tr> </table>	1 = Follow Button  or ●	5 = Follow Bell	2 = Follow Button  or ●	6 = Follow Arm	3 = Follow Zone	7 = Follow Stay arm	4 = Follow Alarm	8 = Follow Sleep arm	
1 = Follow Button  or ●	5 = Follow Bell										
2 = Follow Button  or ●	6 = Follow Arm										
3 = Follow Zone	7 = Follow Stay arm										
4 = Follow Alarm	8 = Follow Sleep arm										
6	If PGM type is 1, 2, 3, or 4 [ACTIVATION DELAY]	<table border="0"> <tr> <td>1 = Follow</td> <td>4 = 15 seconds</td> <td>7 = 5 minutes</td> </tr> <tr> <td>2 = 1 second</td> <td>5 = 30 seconds</td> <td>8 = 15 minutes</td> </tr> <tr> <td>3 = 5 seconds</td> <td>6 = 1 minute</td> <td>9 = 30 minutes</td> </tr> </table>	1 = Follow	4 = 15 seconds	7 = 5 minutes	2 = 1 second	5 = 30 seconds	8 = 15 minutes	3 = 5 seconds	6 = 1 minute	9 = 30 minutes
1 = Follow	4 = 15 seconds	7 = 5 minutes									
2 = 1 second	5 = 30 seconds	8 = 15 minutes									
3 = 5 seconds	6 = 1 minute	9 = 30 minutes									
	If PGM type is 5 Goes to next available PGM.										
	If PGM type is 6, 7, or 8 [1] and/or [2] + [ENTER]	If system is partitioned, select partition(s) and press [ENTER]. Goes to next available PGM.									
7	If PGM type is 1, or 2 [2-DIGIT REMOTE CONTROL #]	01 to 32; 00 = all remote controls. Goes to next available PGM.									
	If PGM type is 3 [2-DIGIT ZONE #]	01 to 32; 00 = all zones. Goes to next available PGM.									
	If PGM type is 4 [1] and/or [2] + [ENTER]	If system is partitioned, select partition(s) and press [ENTER]. Goes to next available PGM.									

Index

Numerics

001 to 032 - Zone definitions	15
033 to 036 - Zone definition templates	15
041 to 056 - Zone timers	17
061 to 092 - Wireless serial #	15
101 to 132 - Wireless transmitter strength	45
141 to 172 - Zone report codes	18
181 to 212 - Zone labels	16
220 to 251 - PGM events	29
261 to 276 - PGM options	34
281 to 296 - PGM delay	35
301 to 316 - PGM serial #s	36
321 to 336 - Wireless PGM strength	36
341 to 356 - PGM labels	29
360 to 376 - REM3 - code entry	53
395 - Installer code lock	50
397 - Installer code	50
398 - Maintenance code	50
399 - System master code	50
400 to 432 - User code options	50
471 to 502 - User report codes	51
511 to 542 - User labels	51
545 to 546 - Wireless repeater assignment	43
548 to 549 - Wireless repeater signal strength	43
551 to 567 - Wireless repeater options	43
568 to 569 - Wireless repeater labels	43
571 to 578 - Wireless keypad assignment	45
587 - Wireless repeater/keypad options	46
587 - Wireless siren supervision	47
588 - Wireless keypad options	46
591 to 598 - Wireless keypad strength	46
599 to 606 - Wireless keypad labels	45
610 to 642 - Remote button assignment	52
651 to 682 - Remote user assignment	53
683 to 686 - Wireless siren assignment	46
687 to 690 - Wireless siren strength	47
691 to 694 - Wireless siren labels	46
695 - Cancel wireless siren tamper supervision	47
700 - General system options	20
700 - Partitioning	19
700 - RF jamming supervision	43
701 - Access code options	50
701 - Keypad options	19
701 - REM2 version #	53
702 - Panic options	20
703 - Keypad options	19
703 - VDMP3 arm/disarm	24
703 to 704 - Arming/disarming options	20
704 - Arming/disarming options	53
704 - Keypad options	19
705 - ATZ options	16
706 - Zone options	17
710 to 721 - System timers	21
732 to 733 - Daylight savings start/end	21
741 to 742 - Partition options	19
745 to 750 - Partition timers	20
761 to 762 - Auto-arm on time	20, 21
771 to 772 - Partition labels	19
780 - SMS site name	28
781 to 795 - Bus module labels	16
800 - Activate dialer (GSM/landline)	25
800 - Dialer options	24
801 - Dialer options	22
802 to 804 - Event call direction	22
805 - GSM options	25
806 - IP/GPRS options	26
810 - Report code format	23
811 to 812 - Partition account #s	23
815 to 819 - Reporting tel. #s	24, 25

820 - Fail to comm. clear event timer	23
830 to 840 - Communication timers	23
841 - VDMP3 max attempts	24
850 - Test report time of day	23
851 to 852 - Report delay	23
855 to 856 - GSM settings	26
860 to 861 - Special arm rep. codes	37
862 - Special disarm rep. codes	37
863 to 864 - Special alarm rep. codes	37
865 to 869 - System trouble rep. codes	37
870 to 874 - System trouble restore rep. codes	37
875 to 878 - System special rep. codes	38
879 - Com. rep. codes	26
879 to 880 - Com. rep. codes	28
881 - Com. restore rep. codes	26
881 to 882 - Com. restore rep. codes	28
884 - GSM lost com. rep. code	26
900 - Winload / BabyWare options	22
901 - Number of rings	23
902 - Answering mchn. delay	23
910 - Panel ID	22
911 - PC password	22
915 - PC telephone number	22
918 to 919 - IP account	26
920 to 927 - WinLoad/BabyWare/PCS100 settings	28
929 to 935 - IP receiver 1 options	27
936 to 942 - IP receiver 2 options	27
943 to 949 - IP receiver backup options	27
950 - Reset all sections	6
955 - Clear bus module trouble	6
960 - Wireless transmitter serial #	6
965 - PGM labels reset	29
965 - Reset bus module labels	16
965 - Reset partition labels	19
965 - Reset user labels	50
965 - Reset zone labels	16
965 - Wireless keypad label reset	45
965 - Wireless repeater/siren labels	43
965 - Wireless repeater/siren labels reset	46
966 - Clear comm. report codes	26
966 - Clear user report codes	51
966 - Clear zone report codes	18
966 to 967 - Clear report codes	36
967 - Reset comm report codes	26
967 - Reset user report codes	51
967 - Reset zone report codes	18
970 - Mem key to panel	6
975 - Panel to mem key	6
980 - Panel version number	6

A

Access Code	
Options	50
Access code	
Length	50
Account numbers	23
Ademco Contact ID	23
Ademco Contact ID report codes	39
Ademco Express	23
Ademco Slow	23
Alarm relay	56
Alarm transmission delay	23
Armed report delay	23
Arming/disarming options	20
ATZ	12
Connections	55
Doubling option	16
Wiring options	16
Audible trouble warning	20
Auto test report	23
Auto test report time of day	23
Auto-arm options	19

B	
BabyWare	
Connecting	57
Instructions	57
Quick menu	66
Through PCS module	28
Battery	
Backup	56
Charging	20
specifications	5
Bus Module	
Clear Trouble	6
Labels	16
C	
Cancel communication	66
Check-in supervision time	17
Codes	7
Communication	
Programming	22
Settings	23
Communicator - quick menu	66
Comparison chart	4
Confidential mode	19
Contact ID override	22
Custom zone definitions	15
D	
Data entry / display	6
Date and time	65
Daylight savings	21
Decimal and hexadecimal values	6
Delay	
Alarm transmission	23
Between dialing attempts	23
Settings	65
Dialer options	24
Dialing - Delay between attempts	23
Disarmed report delay	23
DTMF dialing	24
E	
Entry delay - Display on LCD keypad	19
EOL resistors	17
Event call direction options	22
Exit delay termination	20
F	
Fail to comm. clear event timer	23
Fire circuits	56
Firmware updating	57
G	
GPRS reporting	
Options	26
GSM	
No Service Timer	26
Options	25
SMS Language	26
H	
Hardware connections	55
I	
Installer	
Code	50, 65
Code lock	50
Function keys	41
Quick menu	65
IP account numbers	26
IP receiver configuration	27
IP reporting options	26

IP/GPRS Registration Status	28
-----------------------------------	----

K

Keypad	
Labels (LCD)	47
Letters / Special characters	48
Programming	18
Programming - wireless	45
Zone number	65

L

Labels	50
Bus module	16
Partition	19
PGM labels	29
Reset bus module	16
Reset Partition	19
Reset PGM	29
Reset user	50
Reset wireless keypad	45
Reset wireless siren	46
User	50
Wireless keypad	45
Wireless repeater	43
Wireless siren	46
Zones	16
LCD keypad labels	47
Lock master code	50

M

Maintenance code	50, 65
Maintenance code limited access table	50
Master code lock	50
Memory key - download / upload	6
Metal box installation	58
Monitoring station	
Maximum dialing attempts	23
Telephone number	24, 25, 66

O

One-touch options	19
-------------------------	----

P

Pager reporting	
Delay	23
Message repetition	23
Panel reset	7
Panel version number	6
Panic options	20
Partition	
Timers	20
Partition labels	19
Partitioning	19
PCB layout	61
PCS100	
Connection settings	28
Programming	26
SMS Language	26
Personal reporting	
Delay	23
Message repetition	23
PGM	
Connections	56
Delays	35
Event description	30
Labels	29
Options	34
Programming	29
Quick menu	67
Recognition	29
Serial numbers	36
Wireless signal strength	36
Planning	
PGM	10
System	8

Wireless keypads	9
Wireless sirens	9
Power failure report delay	23
Programmable output	
Options	34
Programming	29

Q

Quick menu	65
------------------	----

R

Recent closing delay	23
REM2 version number	53
REM3 - Action keys	53
Remote control	
Action keys (REM3)	53
Button assignment	52
REM2 version number	53
Serial number display	6
User assignment	53

Report Codes

Clear system report codes	36
Clear user	51
Clear zone report codes	18
Reset system report codes	37
Reset user	51
Reset zone report codes	18
Special arming report codes	37
System Trouble	37

Report codes

Clear codes	36
Clear communication report codes	26
Format	23
Instructions	36
Reset codes	37, 51
Reset communication	26
Special alarm	37
Special arming	37
Special disarming report codes	37
System special	38
System trouble	37
System trouble restore	37
User	51
Wireless	37
Zones	18

Reset panel	7
-------------------	---

Reset sections to factory default	6
---	---

RF jamming supervision	43
------------------------------	----

RPT1 programming	43
------------------------	----

S

Sescoa	23
--------------	----

SIA	23
-----------	----

Signal strength - Wireless transmitter	45
--	----

Silent Knight Fast	23
--------------------------	----

Single zone inputs	55
--------------------------	----

Siren - wireless siren programming	46
--	----

SMS	
-----	--

Language	26
----------------	----

StayD

Entry point zone assignment	18
-----------------------------------	----

Supervision options	17
---------------------------	----

System codes	7
--------------------	---

System master code	50
--------------------------	----

System specifications	61
-----------------------------	----

MG5000	59
--------------	----

MG5050	60
--------------	----

SP5500	62
--------------	----

SP6000	63
--------------	----

SP7000	64
--------------	----

T

Tamper recognition	16
--------------------------	----

Tamper supervision	20
--------------------------	----

TBR-21	2
--------------	---

Telephone number

Backup	24, 25
--------------	--------

Monitoring station	24, 25
--------------------------	--------

Pager	24, 25
-------------	--------

Special keys	24, 25
--------------------	--------

Templates

Zone definitions	15
------------------------	----

Test mode	41
-----------------	----

Test report	41
-------------------	----

Time and date	65
---------------------	----

Timers

Auto-arm	20
----------------	----

Communication	23
---------------------	----

Confidential mode	19
-------------------------	----

General	23
---------------	----

Partition	20
-----------------	----

System	20
--------------	----

Zone	17
------------	----

TLM fail delay	23
----------------------	----

Trouble display	42
-----------------------	----

two-wire smoke - Zone 1 becomes 2-wire smoke	17
--	----

U

UL AND ULC WARNINGS	2
---------------------------	---

User code options	50
-------------------------	----

User labels	50
-------------------	----

V

VDMP3

Calling the VDMP3	24
-------------------------	----

Maximum voice dialing attempts	24
--------------------------------------	----

Version Numbers - Viewing	7
---------------------------------	---

W

Walk test mode	65
----------------------	----

WinLoad

Connecting	57
------------------	----

Instructions	57
--------------------	----

Quick menu	66
------------------	----

Through PCS module	28
--------------------------	----

Wireless keypad

Assignment	45
------------------	----

Labels	45
--------------	----

Options	46
---------------	----

Programming	45
-------------------	----

Signal strength	46
-----------------------	----

Wireless repeater / Keypad options	46
--	----

Wireless repeater programming (RPT1)	43
--	----

Labels	43
--------------	----

Options	43
---------------	----

Signal strength	43
-----------------------	----

Wireless siren

Assignment	46
------------------	----

Labels	46
--------------	----

Options	47
---------------	----

Signal strength	47
-----------------------	----

Wireless siren programming	46
----------------------------------	----

Wireless transmitter signal strength	45
--	----

Z

Zone

Definition templates	15
----------------------------	----

Definitions	14
-------------------	----

Labels	50
--------------	----

Labels - Reset	16
----------------------	----

Programming	12
-------------------	----

Recognition	12
-------------------	----

Timers	17
--------------	----

ZX8 - zone/tamper	17
-------------------------	----

For technical support in Canada or the U.S., call 1-800-791-1919, Monday to Friday from 8:00 a.m. to 8:00 p.m. EST. For technical support outside Canada and the U.S., call 00-1-450-491-7444, Monday to Friday from 8:00 a.m. to 8:00 p.m. EST. Please feel free to visit our website at www.paradox.com

The whole Paradox team wishes you a successful and easy installation.
We hope this product performs to your complete satisfaction. Should you have any questions or comments, please visit www.paradox.com.



Printed in Canada - 02/2010

MGSP-EP21